

**Workers' Compensation Information System
(WCIS)**

**California EDI Implementation Guide
for First and Subsequent Reports
of Injury (FROI/SROI)**

Version ~~3.0~~ 3.1

**November 15, 2011 (DATE TO BE INSERTED BY OAL – 6 12
MONTHS FOLLOWING APPROVAL AND FILING WITH SECRETARY OF
STATE)**



**CALIFORNIA DEPARTMENT OF INDUSTRIAL RELATIONS
~~JOHN DUNCAN~~ CHRISTINE BAKER, DIRECTOR**

**DIVISION OF WORKERS' COMPENSATION
~~CARRIE NEVANS, DESTIE OVERPECK,~~ GEORGE PARISOTTO, ACTING
ADMINISTRATIVE DIRECTOR**

~~January 1, 2011 July 1, 2012 April 4, 2014 February 1, 2016~~

Dear Claims Administrators:

Welcome to Electronic Data Interchange (EDI). The California Division of Workers' Compensation (DWC) is pleased to introduce its revised system for receiving workers' compensation claims data via EDI. This data will be integrated with related industry data to make up our Workers' Compensation Information System, which is becoming a rich resource for analyzing the performance of California's workers' compensation system.

This revised manual, the *California EDI Implementation Guide For First and Subsequent Reports of Injury*, is intended to be a primary resource for the organizations that comprise the Division's "trading partners" – claims administrators for California workers' compensation claims.

Most reporting organizations already have substantial experience with EDI, and transmit data to workers' compensation agencies in many states. For them, this *Implementation Guide* can serve as a reference for California-specific protocols. While we have adhered to national EDI standards, California's implementation does have minor differences from other states' protocols.

The *Implementation Guide* also includes background information for organizations new to EDI. If your organization is just getting started, the "Overview of EDI" and the "Managers' Guide" are for you. You will also find numerous valuable resource materials.

This *Implementation Guide* will remain under development for some time. As both the Division and our EDI trading partners gain experience with California's EDI system, updates to the *Guide* will be posted on our Web site at <http://www.dir.ca.gov/dwc/wcis.htm>.

I hope that, if you are new to reporting via EDI, your start-up of reporting in California will be as smooth and as painless as possible, both for the Division and for our EDI trading partners. DWC is dedicated to full, open communication as a cornerstone of a successful start-up process, and this *Implementation Guide* is a key element of that communication.

Sincerely,

~~CARRIE NEVANS~~
~~DESTIE OVERPECK~~
GEORGE PARISOTTO
Acting Administrative Director

Table of Contents

<u>Welcome to Electronic Data Interchange (EDI)</u>	ii
<u>Section A: EDI in California – An Overview</u>	1
EDI – Electronic Data Interchange	1
California’s WCIS – the Workers’ Compensation Information System.....	2
California EDI Requirements	3
Sending Data to the WCIS	3
<u>Section B: Where to Get Help – Contacting WCIS and Other Information Resources</u>	6
California Division of Workers’ Compensation	6
EDI Service Providers	7
IAIABC	8
<u>Section C: Implementing EDI – A Managers’ Guide</u>	9
<u>Section D: Authorizing Statutes – Labor Code sections 138.6 and 138.7....</u>	13
Labor Code section 138.6 Development of workers’ compensation information system	13
Labor Code section 138.7 “Individually identifiable information”; restricted access.....	13
<u>Section E: Legal Authorities</u>	17
<u>Section F: Trading Partner Profile</u>	19
<u>Section G: Test, Pilot, Parallel and Production Phases of EDI</u>	30
Step 1. Complete an EDI Trading Partner Profile	30
Step 2. Complete the Test Phase.....	32
Step 3. Complete the Pilot Phase.....	36
Step 45. Production	43
<u>Section H: File Formats and Supported Transactions</u>	47
<u>Section I: The SFTP (SSH (Secure Shell) File Transfer Protocol) Transmission Modes</u>	48
Data Transmission with File Transfer Protocol-SFTP (SSH (Secure Shell) File Transfer Protocol)	48
Transmission Pathways.....	52
<u>Section J: Events that Trigger Required EDI Reports</u>	53
First Report of Injury	53
Subsequent Report of Injury	54

Annual Summary	55
<u>Section K: Required Data Elements</u>	<u>56</u>
WCIS Data Requirement Codes.....	57
Data Requirements for First Reports of Injury.....	58
FROI Conditional Rules and Implementation Notes.....	61
Data Requirements for Subsequent Report of Injury	65
SROI Conditional Rules and Implementation Notes	69
<u>Section L: California-Specific Data Edits and Sorted Adopted IAIABC Data Element Lists.....</u>	<u>74</u>
All Transactions	74
First Reports (FROIs)	74
Subsequent Reports (SROIs).....	76
FROI Data Elements, Sorted by Data Element Number (DN)	81
SROI Data Elements, Sorted By Data Element Number (DN).....	85
<u>Section M: System Specifications.....</u>	<u>88</u>
Agency Claim Number/Jurisdiction Claim Number (JCN).....	88
Changed or Corrected Data	88
Transaction Processing and Sequencing.....	89
General Rules.....	89
First Reports	90
First Report Transaction Sequencing Requirements Summary.....	91
Subsequent Reports	91
Transaction Sequencing Requirements for Subsequent Reports.....	94
Sequencing Rules	94
Related Business Rules	94
WCIS Matching Rules and Processes	95
FROI Matching Process for Original '00' MTC	97
FROI Matching Process for Cancel '01' MTC	99
FROI Matching Process for Change '02' or Correction 'CO' MTC.....	100
FROI Matching Process for Denial '04' MTC	101
FROI Matching Process for Acquired Claim 'AU' MTC	103
SROI Matching Process for All SROI MTCs	104
<u>Section N: Code Lists.....</u>	<u>105</u>
Nature of Injury Codes (DN35)	105
Part of Body Codes (FROI DN36) and SROI (DN83)	105
Cause of Injury Codes (DN37)	105

Late Reason Codes (DN77)	113
Class Codes (DN59).....	114
Payment/Adjustment and Paid to Date (DN85 and DN95) Benefit Type Codes.....	115
Industry Codes (DN25).....	116
Section O: EDI Terminology	117
Abbreviations and Acronyms.....	117
EDI Glossary.....	118
Appendix A: Revised WCIS System Updates.....	122
Differences Between Version 3.0 and Version 3.1 of WCIS FROI/SROI.....	123
Differences Between Version 2.1 and Version 3.0 of WCIS:	126
Differences Between Version 2.0 and Version 2.1 of WCIS:	128
Appendix B: Revision History – Summary of Principal Changes from Previous Versions.....	130
Version 3.1.....	130
Version 3.0.....	132
Version 2.1.....	133
Version 2.0.....	135
Version 1.2.....	137
Version 1.1.....	138
Version 1.02.....	138
Version 1.01.....	139
Version 1.00.....	139

Welcome to Electronic Data Interchange (EDI)	i
Section A: EDI in California – An Overview	1
EDI – Electronic Data Interchange	1
Benefits of EDI within Workers' Compensation	1
California's WCIS – the Workers' Compensation Information System	2
History	2
WCIS Data Collection	2
California EDI Requirements	3
Sending Data to the WCIS	3
The Five Step Process of EDI – From Testing to Production	5
Step 1: EDI Trading Partner Profile	5
Step 2: Testing	5
Step 3: Pilot	5
Step 4: Parallel (optional)	5
Step 5: Production	5
Section B: Where to Get Help – Contacting WCIS and Other Information Resources	6
California Division of Workers' Compensation	6
Our Web Site	6
Your WCIS Contact Person	6
WCIS e-News	7
EDI Service Providers	7
IAIABC	8
Section C: Implementing EDI – A Managers' Guide	9
1. Get to know the basic requirements	9
2. Assign responsibilities for implementing EDI	9
3. Decide whether to contract with an EDI service provider	9
4. If your organization will not use an EDI service provider, choose a file format and transmission mode for your data	10
5. Make sure your computer systems contain all the required data	10
6. Determine who will handle error messages sent by WCIS	10
7. Decide whether your organization could benefit by adding data edits	11
8. Install any software and communications services you will need	11
9. Test your system internally	12
<i>November 15, 2011</i>	<i>ii</i>
10. Move through the Test, Pilot and Parallel stages to reach the Production stage of EDI transmission	12

11. Evaluate the efficiency of your EDI system and consider future refinements	12
Section D: Authorizing Statutes – Labor Code sections 138.6 and 138.7 ...	13
Labor Code section 138.6 Development of workers' compensation information system	13
Labor Code section 138.7 "Individually identifiable information"; restricted access	13
Section E: Legal Authorities	16
Pertinent WGIS Regulations	16
Additional Regulations Related to Filing Employer's First Reports of Injury	16
Letter from DIR regarding electronic filing	16
Section F: Trading Partner Profile	18
Who Should Complete the Trading Partner Profile?	18
ELECTRONIC DATA INTERCHANGE TRADING PARTNER PROFILE	19
INSTRUCTIONS FOR COMPLETING TRADING PARTNER PROFILE	23
Section G: Test, Pilot, Parallel and Production Phases of EDI	29
Step 1. Complete an EDI Trading Partner Profile	29
Step 2. Complete the Test Phase	31
Purpose	31
Order of Testing	31
Test Criteria	32
Test Procedure	32
Step 3. Complete the Pilot Phase	35
Overview	35
Purpose	35
Data Quality Criteria	36
Maintenance Type Codes Piloted	37
Step 4. Parallel Procedure (Optional)	38
Moving from Parallel to Production Status	41
Step 5. Production	41
Paper Reports	41
Data Quality Requirements	42
Data Quality Reports	42
Trading Partner Profile	42
WGIS PARALLEL BATCH IDENTIFICATION FORM	43
Section H: File Formats and Supported Transactions	44
Supported Transactions	44
Understanding ANSI and Flat Files	44
Section I: The FTP Transmission Modes	45
File Transfer Protocol (FTP)	45
Data Transmission with File Transfer Protocol	45

Transmission Pathways	48
Section J: Events that Trigger Required EDI Reports	49
First Report of Injury	49
Subsequent Report of Injury	50
Annual Summary	51
Section K: Required Data Elements	52
WCIS Data Requirement Codes	53
Data Requirements for First Reports of Injury	54
FROI Conditional Rules and Implementation Notes	57
Data Requirements for Subsequent Report of Injury	59
SROI Conditional Rules and Implementation Notes	63
Section L: California-Specific Data Edits and Sorted Data Element Lists ...	67
All Transactions	67
First Reports (FROIs)	67
Subsequent Reports (SROIs)	68
FROI Data Elements, Sorted by Data Element Number (DN)	69
FROI Data Elements, Sorted Alphabetically	71
SROI Data Elements, Sorted By Data Element Number (DN)	73
SROI Data Elements, Sorted Alphabetically	74
Section M: System Specifications	76
Agency Claim Number/Jurisdiction Claim Number (JCN)	76
Changed or Corrected Data	76
Transaction Processing and Sequencing	77
General Rules	77
First Reports	78
First Report Transaction Sequencing Requirements Summary	79
Subsequent Reports	79
Transaction Sequencing Requirements for Subsequent Reports	81
Sequencing Rules	82
Related Business Rules	82
WCIS Matching Rules and Processes	82
Acquired Claims	84
Section N: Code Lists	85
Nature of Injury Codes (DN35)	85
Part of Body Codes: FROI (DN36) and SROI (DN83)	87
Cause of Injury Codes (DN37)	90
Late Reason Codes (DN77)	92
Class Codes (DN59)	93

Payment/Adjustment and Paid to Date (DN85 and DN95) Benefit Type Codes	94
Industry Codes (DN25)	95
Section O: EDI Terminology	96
Abbreviations and Acronyms	96
EDI Glossary	97
Appendix A: Revised WCIS System Updates	101
Clarification of Issues	101
Differences Between Version 2.1 and Version 3.0 of WCIS	102
Differences Between Version 2.0 and Version 2.1 of WCIS	104
Appendix B: Revision History – Summary of Principal Changes from Previous Versions	106
Version 3.0	106
Version 2.1	107
Version 2.0	109
Version 1.2	111
Version 1.1	112
Version 1.02	112
Version 1.01	113
Version 1.00	113

DRAFT

DRAFT

Section A: EDI in California – An Overview

EDI – Electronic Data Interchange

Electronic Data Interchange (EDI) is the computer-to-computer exchange of data or information in a standardized format. In workers' compensation, EDI refers to the electronic transmission of claims information from claims administrators (insurers, self-insured employers, and third party administrators) to a State Workers' Compensation Agency.

Data are transmitted in a format standardized by the International Association of Industrial Accident Boards and Commissions (IAIABC). The IAIABC is a professional association of workers' compensation specialists from the public and private sectors and has spearheaded the introduction of EDI in workers' compensation. All collected data elements are reviewed for valid and standardized business definitions and formats.

Benefits of EDI within Workers' Compensation

- **Allows state agencies to respond to policy makers' questions regarding their state programs**

Electronic data interchange allows states to evaluate the effectiveness and efficiency of their workers' compensation system by providing comprehensive and readily accessible information on all claims. This information can then be made available to state policy makers considering any changes to the system.

- **Avoids costs in paper handling**

Electronic data interchange reduces costs in the processing of paper documents for the claims administrator and the jurisdiction: mail processing costs, duplicated data entry costs, shipping, filing and storage costs.

- **Increases data quality**

Electronic data interchange has built-in data quality checking procedures that are triggered when data are received by the state agency. Many claims administrators choose to replicate these data-checking procedures to reduce the cost of data correction.

- **Simplifies reporting requirements for multi-state insurers**

Electronic data interchange helps claims administrators cut costs by having a single system for internal data management and reporting.

California's WCIS – the Workers' Compensation Information System

History

The California Legislature enacted sweeping reforms to California's workers' compensation system in 1993. The reform legislation was preceded by a vigorous debate among representatives of injured workers, their employers, insurance companies, and medical providers. All parties agreed that changes were due, but they could not reach agreement on the nature of the problems to be corrected nor on the likely impact of alternative reform proposals. One barrier to well-informed debate was the absence of comprehensive, impartial information about the performance of California's workers' compensation system.

Foreseeing the strengths and weaknesses of the system, the Legislature directed the Division of Workers' Compensation (DWC) to put together comprehensive information about workers' compensation in California. The result is the WCIS--the Workers' Compensation Information System. The WCIS has been in development since 1995, and its design has been shaped by a broad-based advisory committee. The WCIS has four main objectives:

- help DWC manage the workers' compensation system efficiently and effectively,
- facilitate the evaluation of the benefit delivery system,
- assist in measuring benefit adequacy,
- provide statistical data for further research.

WCIS Data Collection

The core of the system is standardized data on every California workers' compensation claim. Much of this data has historically been collected in paper form: employers' and physicians' first reports of injury and benefit notices. Beginning in 2000, standardized data was transmitted to the WCIS by EDI. These EDI transmissions are the main subject of this Guide. EDI reporting allows DWC to understand and improve the California workers' compensation system.

California EDI Requirements

California's WCIS regulations define EDI reporting requirements for claims administrators. A claims administrator is an insurer, a self-insured employer, or a third-party administrator.

In brief, claims administrators are required to submit the following:

First Reports: First Reports of Injury (FROIs) must be submitted by EDI to WCIS in the Division of Workers' Compensation (DWC) no later than 10 business days after claim administrator knowledge of the claim.

Subsequent Reports: Subsequent Reports of Injury (SROIs) are submitted within 15 business days whenever benefit payments to an employee are started, changed, suspended, restarted, stopped, delayed or denied or when a claim is closed, **reopened** or upon notification of employee representation.

Medical Bill/Payment Records: Medical bill payment reporting regulations require medical services with a date of service on or after September 22, 2006 and a date of injury on or after March 1, 2000 to be transmitted to the DWC within 90 calendar days of the medical bill payment or the date of the final determination that payment for billed medical services would be denied. These medical services are required to be reported to the WCIS by all claims administrators handling 150 or more total claims per year.

Annual Summary of Benefits: An Annual Summary of Benefits must be submitted for every claim with any benefit activity (including medical) during the preceding calendar year. The annual summary report is due by January 31 and must report the cumulative totals of any benefits paid as of December 31 of the preceding calendar year.

~~Section E – Legal Authorities includes the full WCIS regulations along with a more detailed summary.~~

Sending Data to the WCIS

Workers' compensation claims are handled by diverse organizations: large multi-state insurance companies, smaller specialty insurance carriers, self-insured employers, and third-party administrators handling claims on behalf of insured and self-insured employers. These organizations have different information systems and capabilities. The WCIS has been designed to be as flexible as possible in the support of a variety of EDI systems.

The allowed methods of transmitting data from claim administrators to WCIS are [is](#):

- [SFTP also known as SSH \(Secure Shell\)](#) File Transfer Protocol (FTP) over SSL (Secure Sockets Layer), also known as FTPS, or
- ~~FTPS with PGP (Pretty Good Privacy) encryption.~~

The electronic communications options are described more fully in Section H—File Formats and Supported Transactions and Section I—Transmission Modes. The WCIS is also flexible in supporting two different file formats, known as American National Standards Institute (ANSI) X12 and “flat-file” formats.

Claim administrators can avoid the details of EDI by selecting among several firms that sell EDI-related software products, consulting, and related services.

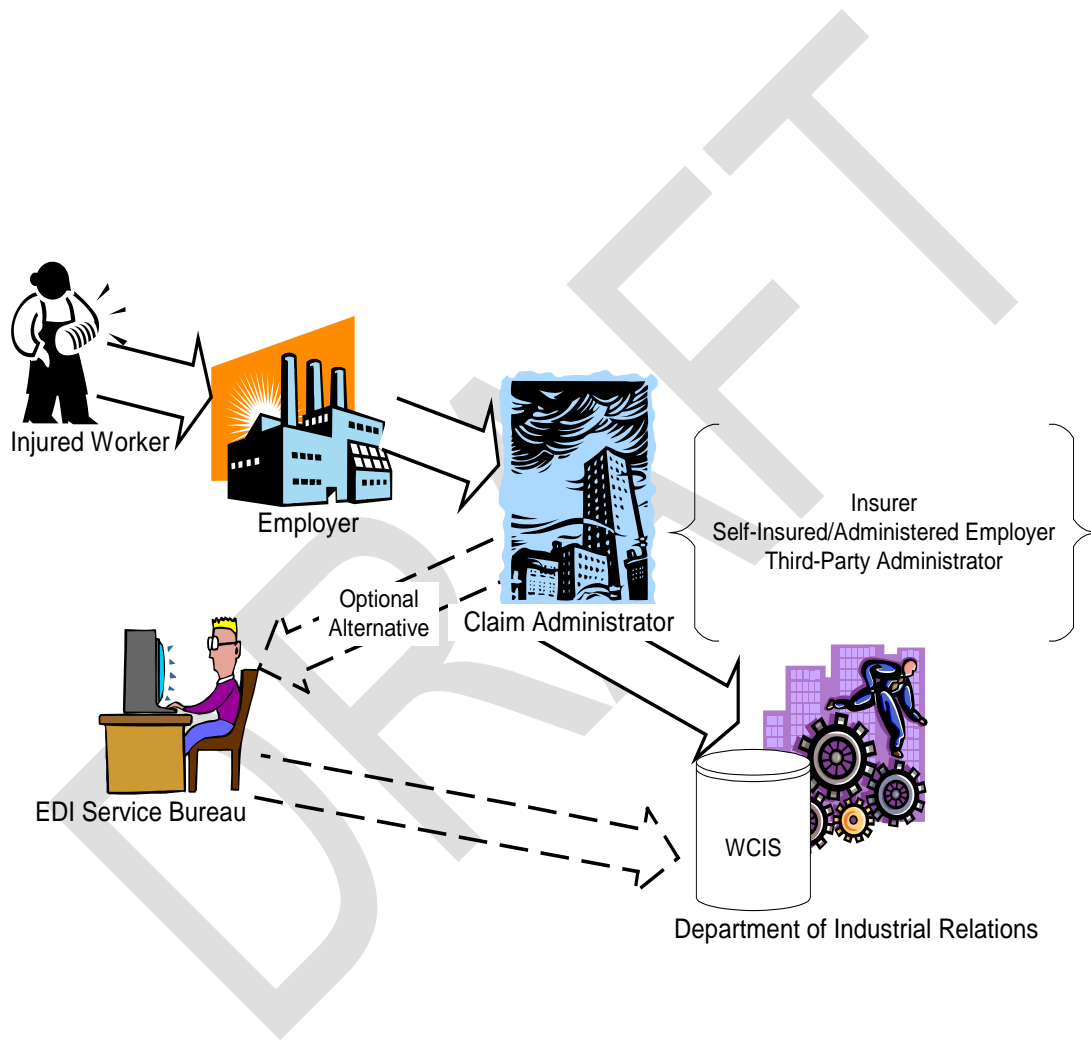

The Five ~~Four~~ Step Process of EDI—From Testing to Production

Full production EDI reporting status is a five ~~four~~ step process. Each step of the process is described in more detail in Section G—Test, Pilot, Parallel and Production Phases of EDI. These steps should be repeated each time the claims administrator is ready to move into a new transaction type, i.e., the First Reports and Subsequent Reports.

Step 1: EDI Trading Partner Profile

The claims administrator first provides an EDI Trading Partner Profile to the Division at least 30 (thirty) days before its first submission of EDI data. The Trading Partner Profile form is provided in Section F—Trading Partner Profile. The Trading Partner Profile is used to prepare WCIS for your data transmission: what file format to expect, where to send an acknowledgment, when you plan to transmit reports, and similar information.

The claims administrator runs a preliminary test by transmitting a test file to ensure that the WCIS system can read and interpret the data. The claims administrator has passed the test when minimum technical requirements are met: WCIS recognizes the sender, the file format is correct, and the claims administrator can receive electronic acknowledgments from WCIS.

Step 2: Testing

The claims administrator runs a preliminary test by transmitting a test file to ensure that the WCIS system can read and interpret the data. The claims administrator has passed the test when minimum technical requirements are met: WCIS recognizes the sender, the file format is correct, and the claims administrator can receive electronic acknowledgments from WCIS.

Step 3: Pilot

After a test file is successfully transmitted, real claims data is transmitted in the Pilot stage. During the Pilot step, data submissions are analyzed for completeness, validity, and accuracy. The data should meet minimum data quality requirements in order to complete the Pilot stage.

Step 4: Parallel (optional)

The claims administrator submits reports both electronically and in hard copy during the Parallel phase. The WCIS uses these parallel reports to conduct a comparison study.

Step 4 5: Production

During Production, data transmissions will be monitored for completeness, validity, and accuracy. Each Trading Partner will be routinely sent reports describing their data quality. Those in Production status for EDI First Reports will no longer be required to send paper copies of the Employer's Report (Form 5020) to Department of Industrial Relation's Division of Labor Statistics and Research (DLSR).

Section B: Where to Get Help – Contacting WCIS and Other Information Resources

Starting up a new EDI system isn't simple. It requires detailed technical information, as well as close cooperation between the organizations that send data, the trading partners and the organization that receives data, the California Division of Workers' Compensation (DWC). The following is a list of resources available for information and assistance.

California Division of Workers' Compensation

Our Web Site

Visit our web site at <http://www.dir.ca.gov/dwc/WCIS.htm> to:

- Download the latest version of the *California EDI Implementation Guide for First and Subsequent Reports of Injury (FROI/SROI)*,
- Get answers to *Frequently Asked Questions*,
- Review archived *WCIS e-News* letters.

Your WCIS Contact Person

Each WCIS Trading Partner will be assigned a WCIS contact person at DWC. This person will help answer your questions about EDI reporting in California, work with you during the Test-Pilot-Parallel-Production process, and be an ongoing source of support during production.

Your WCIS liaison can be reached by phone, e-mail, or mail. When initially contacting us, be sure to provide your company name so that you may be directed to the appropriate WCIS staff.

By phone: ~~(510)286-6753~~ (510)286-1263 Trading Partner Letters C, G-H, M, P-R
 (510)286-6763 Trading Partner Letters B, D-F, N-O, W-Y
 (510)286-6772 Trading Partner Letters A, I-L, S-V, Z

By fax: ~~(510)286-6862~~

By e-mail: wcis@dir.ca.gov

By mail: WCIS EDI Unit
 Attn: Name of WCIS Contact (if known)
 Department of Industrial Relations
 1515 Clay St, ~~Ste 1902~~
 Oakland, CA 94612

If you find errors or omissions in the California EDI Implementation Guide (FROI/SROI), please inform your WCIS contact person.

November 15, 2011 (DATE TO BE INSERTED BY OAL - 6 12 6 MONTHS FOLLOWING APPROVAL AND FILING WITH SECRETARY OF STATE)

WCIS e-News

WCIS e-News is an e-mail newsletter sent out periodically to inform WCIS Trading Partners of announcements and technical implementations. The WCIS e-News will be archived on the WCIS web site. Interested parties who are not already receiving WCIS e-News can register ~~at the WCIS website to be added to the WCIS e-News mailing list~~ by sending an email to wcis@dir.ca.gov with the subject, "Subscribe e-News".

WCIS Training Bulletins

WCIS Training Bulletins are informational e-mails issued by DWC to help improve data quality for the most common errors in WCIS reporting. The WCIS Training Bulletins are archived on the WCIS web site. Interested parties who are not already receiving WCIS Training Bulletins can register by sending an email to wcis@dir.ca.gov with the subject, "Subscribe Training Bulletin".

EDI Service Providers

Several companies can assist you in your efforts to report data via EDI. A range of products and services are available, including:

- software that works with your organization's computer systems to automatically transmit data,
- systems consulting, to help get your computer systems EDI-ready,
- data transcription services which accept paper forms, keypunch data, and transmit the data via EDI.

A list of companies known to DWC that provide these services can be found at <http://www.dir.ca.gov/DWC/EDIVend.HTM>.

Claims administrators seeking assistance in implementing EDI may wish to consult one or more of the EDI service providers listed on the DWC website. Many of these firms offer a full range of EDI-related services: consultation, technical support, value added network (VAN) services, and/or software products. These products and services can make it possible for claims administrators to successfully transmit claims data via EDI and avoid the technical details of EDI.

Another alternative to developing a complete EDI system is to contract for the services of a data collection agent. For a fee, a data collection agent will receive paper forms by fax or mail, enter the data, and transmit it by EDI to state agencies or other electronic commerce trading partners.

The California Division of Workers' Compensation does not have a process for granting "approvals" to any EDI service providers. Listings of providers, which are found on the Division's website, are simply of providers known to the Division. The lists will be updated as additional resources become known.

~~November 15, 2011~~ (DATE TO BE INSERTED BY OAL – 6-12-6 MONTHS FOLLOWING APPROVAL AND FILING WITH SECRETARY OF STATE)

Appearance on the EDI service provider lists does not in any way constitute an endorsement of the companies listed or a guarantee of the services they provide. Other companies not listed may be equally capable of providing EDI-related services.

Note to suppliers of EDI-related services: Please contact wcis@dir.ca.gov if you wish to have your organization added or removed from DWC's list, or to update your contact information.

IAIABC

The International Association of Industrial Accident Boards and Commissions (IAIABC) is the organization that sets the national standards for the transmission of workers' compensation claims data via EDI. The IAIABC publishes these standards in their EDI Implementation Guide.

For more information about the IAIABC and how to purchase the IAIABC EDI Implementation Guide, visit the IAIABC web site at <http://www.iaiabc.org>. The WCIS follows the IAIABC Release 1 reporting standard.

Section C: Implementing EDI – A Managers' Guide

1. Get to know the basic requirements.

Starting up a new EDI system can be a complex endeavor. Make sure you understand all that is required *before* investing resources. Otherwise, you may end up with a collection of piecemeal fixes rather than a comprehensive solution.

This guide and the IAIABC guide contain much of the information needed to implement EDI in California. As more information becomes available it will be posted on our Web site at <http://www.dir.ca.gov/dwc/WCIS.htm>.

2. Assign responsibilities for implementing EDI.

Some organizations put an Information Systems (IS) manager in charge, while others designate a claims manager. Implementing EDI will affect your information system, flow of claims information and your business process. The most effective approach may be to have Claims and Information Systems departments collaborate on the project.

Regardless of who is assigned primary responsibility, make sure that both Claims and IS departments maintain continual oversight as your solution is designed and implemented.

3. Decide whether to contract with an EDI service provider.

Formatting electronic records and transmitting them by EDI generally requires some specialized automated routines. Programming a complete EDI system also requires in-depth knowledge of EDI standards and protocols.

Some organizations choose to develop these routines in-house, especially if they have an IS department that is familiar with EDI and is efficient in bringing new technology online.

Other organizations choose to contract with vendors for dedicated EDI software or services. Typically, an EDI vendor's products interface with your organization's data to produce EDI transactions in the required formats. The benefit is that no one in your organization has to learn all the intricacies of EDI. The service provider takes care of file formats, record layouts, and many other details that may seem foreign to your organization. Some EDI vendors can also provide full-service consulting, helping you update your entire data management process for electronic commerce.

A list of known EDI vendors can be found on the DWC website: <http://www.dir.ca.gov/dwc/EDIVend.HTM>.

4. If your organization will not use an EDI service provider, choose a file format and transmission mode for your data.

Contracting with an EDI service provider would relieve your organization of the detailed mechanics of EDI, such as file formats and transmission modes. If you decide to develop your own system, you will have some important decisions to make that will determine the scope and difficulty of the programming work.

Probably the most important decision is whether your data will be packaged as “flat files” or as “ANSI X12 files.” More information on these choices is provided in Section H—File Formats and Supported Transactions. In general, Release 1 flat files are relatively easy to get up and running quickly. ANSI X12 may be a wise investment in long-run flexibility and compatibility.

Information about file formats can be found in the *IAIABC EDI Release 1 Implementation Guide*, at <http://www.iaiabc.org>. This guide is essential if you will be programming your own EDI system.

You will also need to choose [support the](#) a [SFTP](#) transmission mode that WCIS [requires](#). See Section I—The [SFTP](#) Transmission Modes - for further information.

5. Make sure your computer systems contain all the required data.

You’ll have a hard time submitting data by EDI if the data are not readily accessible on your systems. Give your Information Systems department a copy of Section K—Required Data Elements.

If all are available and readily accessible, then you are in great shape. If not, your Claims and IS departments will need to develop and implement a plan for capturing, storing, and accessing the necessary data.

6. Determine who will handle error messages sent by WCIS.

Your organization will receive “error messages” from WCIS if you transmit data that cannot be interpreted or do not meet the regulatory requirements to provide complete, valid and accurate data.

Some glitches are inevitable. You’ll need a system for forwarding any error messages to people who can respond as necessary.

Establish a procedure for responding to error messages before you begin transmitting data by EDI. Otherwise, your organization may find itself unprepared for the inevitable.

Typically, errors related to technical problems may be aggravating when a system is new, but they quickly become rare. Error messages related to data quality and completeness are harder to correct, and you can expect them to present an ongoing workload that must be managed.

7. Decide whether your organization could benefit by adding data edits.

Data you transmit to the WCIS will be subjected to edit rules to assure that the data are valid and consistent with data previously reported for a particular claim. For example, one edit rule would reject an injury date of February 31. Another rule would reject a benefit notice if a First Report had not been previously filed. These edit rules are detailed in Section K—Required Data Elements, Section L—California-Specific Data Edits, and Section M—System Specifications. Data that violate these edit rules will cause transmissions to be rejected or will be returned with error messages.

Correcting erroneous data often requires going to the original source, perhaps the applicant or the policyholder. In some organizations, the data passes through many hands before it is transmitted to WCIS. For example, the injury type and cause may be initially reported by the applicant, then go through the employer, a claims reporting center, a data entry clerk, a claims adjuster, and an Information Systems department. Any error messages would typically be passed through the same hands in the opposite direction.

An alternative is to install in your system, as close as possible to the original source of data, data edits that match the WCIS edit rules. As an example, consider a claims reporting center in which claims data are entered directly into a computer system, and the system has data edits in place. Most data errors could be caught and corrected while the employer was still on the phone. This eliminates the expense of passing bad data from hand to hand and back again.

8. Install any software and communications services you will need.

Once your system is planned, you will need to purchase and/or develop any software and services for your system

Most systems will need at least the following:

- ◆ software (or other means) to identify events that trigger required reports,
- ◆ software (or other means) to gather required data elements from your databases,
- ◆ software (or other means) to format the data into an approved EDI file format,
- ◆ a File Transfer Protocol (FTP) process that sends EDI files,
- ◆ an FTP process to receive acknowledgments and error messages from WCIS.

Some organizations, especially those that handle few California claims, may wish to contract for EDI services rather than handle EDI in-house. EDI service providers offer all the services listed above--see the DWC website, <http://www.dir.ca.gov/dwc/EDIVend.HTM>.

9. Test your system internally.

Not every system works perfectly the first time. Make sure your system gets thoroughly tested before you begin reporting data to WCIS. Catching any bugs internally will spare you the blizzard of error messages that a faulty system can cause.

Include in your internal tests some complex test cases as well as simple ones. For example, challenge your system with claims that feature multiple episodes of disability and partial return to work. Fix any identified problems before you try transmitting EDI data to WCIS.

10. Move through the ~~Testing and Pilot~~ and ~~Parallel~~ stages to reach the Production stage of EDI transmission.

Complete an EDI Trading Partner Profile and insurer/claim administrator ID list--see Section F--Trading Partner Profile. The Profile and ID list are used to prepare WCIS for your data transmission: what file format to expect; where to send your acknowledgments; when you plan to transmit reports; and similar information.

Once you have completed a successful test and verified that your transmissions match our technical specifications, you will be ready to enter the Pilot stage. ~~During the optional Parallel stage, a sample of your EDI transmissions will be compared with the paper reports, and will also be tested against the WCIS data validation rules.~~

Upon your successful completion of the ~~Parallel step~~, Pilot step DWC will issue you a written determination that you have demonstrated capability to transmit complete, valid, and accurate data. You will then be authorized to move into the Production stage, routinely transmitting your data via EDI.

11. Evaluate the efficiency of your EDI system and consider future refinements.

Many organizations find that implementing EDI brings unexpected benefits. For example, EDI may provide an opportunity to address long-standing data quality problems.

Arrange a review session after your system has been running for a few months. Users will be able to suggest opportunities for future refinements. Managers from departments not directly affected may also be interested in participating because EDI may eventually affect many business processes in other departments.

Please let us know if you have any comments on this Manager's Guide.

We can't anticipate every challenge you may face in implementing EDI data reporting. Please e-mail any comments or suggestions you may have to wcis@dir.ca.gov

Section D: Authorizing Statutes – Labor Code sections 138.6 and 138.7

Labor Code section 138.6

Development of workers' compensation information system

(a) The administrative director, in consultation with the Insurance Commissioner and the Workers' Compensation Insurance Rating Bureau, shall develop a cost-efficient workers' compensation information system, which shall be administered by the division. The administrative director shall adopt regulations specifying the data elements to be collected by electronic data interchange.

(b) The information system shall do the following:

(1) Assist the department to manage the workers' compensation system in an effective and efficient manner.

(2) Facilitate the evaluation of the efficiency and effectiveness of the benefit delivery system.

(3) Assist in measuring how adequately the system indemnifies injured workers and their dependents.

(4) Provide statistical data for research into specific aspects of the workers' compensation program.

(c) The data collected electronically shall be compatible with the Electronic Data Interchange System of the International Association of Industrial Accident Boards and Commissions. The administrative director may adopt regulations authorizing the use of other nationally recognized data transmission formats in addition to those set forth in the Electronic Data Interchange System for the transmission of data required pursuant to this section. The administrative director shall accept data transmissions in any authorized format. If the administrative director determines that any authorized data transmission format is not in general use by claims administrators, conflicts with the requirements of state or federal law, or is obsolete, the administrative director may adopt regulations eliminating that data transmission format from those authorized pursuant to this subdivision.

Labor Code section 138.7

"Individually identifiable information"; restricted access.

(a) Except as expressly permitted in subdivision (b), a person or public or private entity not a party to a claim for workers' compensation benefits may not obtain individually identifiable information obtained or maintained by the division on that claim. For purposes of this section, "individually identifiable information" means any data concerning an injury or claim that is linked to a uniquely identifiable employee, employer, claims administrator, or any other person or entity.

(b)(1) The administrative director, or a statistical agent designated by the administrative director, may use individually identifiable information for purposes of creating and maintaining the workers' compensation information system as specified in Section 138.6.

(2) (A) The State Department of Public Health Services may use individually identifiable information for purposes of establishing and maintaining a program on occupational health and occupational disease prevention as specified in Section 105175 of the Health and Safety Code.

(2) (B) (i) The State Department of Health Care Services may use individually identifiable information for purposes of seeking recovery of Medi-Cal costs incurred by the state for treatment provided to injured workers that should have been incurred by employers and insurance carriers pursuant to Article 3.5 (commencing with Section 14124.70) of Chapter 7 of Part 3 of Division 9 of the Welfare and Institutions Code.

(ii) The Department of Industrial Relations shall furnish individually identifiable information to the State Department of Health Care Services, and the State Department of Health Care Services may furnish the information to its designated agent, provided that the individually identifiable information shall not be disclosed for use other than the purposes described in clause (i). The administrative director may adopt regulations solely for the purpose of governing access by the State Department of Health Care Services or its designated agents to the individually identifiable information as defined in subdivision (a).

(3)(A) Individually identifiable information may be used by the Division of Workers' Compensation, the Division of Occupational Safety and Health, and the Division of Labor Statistics and Research as necessary to carry out their duties. The administrative director shall adopt regulations governing the access to the information described in this subdivision by these divisions. Any regulations adopted pursuant to this subdivision shall set forth the specific uses for which this information may be obtained.

(B) Individually identifiable information maintained in the workers' compensation information system and the Division of Workers' Compensation may be used by researchers employed by or under contract to the Commission on Health and Safety and Workers' Compensation as necessary to carry out the commission's research. The administrative director shall adopt regulations governing the access to the information described in this subdivision by commission researchers. These regulations shall set forth the specific uses for which this information may be obtained and include provisions guaranteeing the confidentiality of individually identifiable information. Individually identifiable information obtained under this subdivision shall not be disclosed to commission members. No individually identifiable information obtained by researchers under contract to the commission pursuant to this subparagraph may be disclosed to any other person or entity, public or private, for a use other than that research project for which the information was obtained. Within a reasonable period of time after the research for which the information was obtained has been

November 15, 2011 (DATE TO BE INSERTED BY OAL - 6-12-6 MONTHS FOLLOWING APPROVAL AND FILING WITH SECRETARY OF STATE)

completed, the data collected shall be modified in a manner so that the subjects cannot be identified, directly or through identifiers linked to the subjects.

(4) The administrative director shall adopt regulations allowing reasonable access to individually identifiable information by other persons or public or private entities for the purpose of bona fide statistical research. This research shall not divulge individually identifiable information concerning a particular employee, employer, claims administrator, or any other person or entity. The regulations adopted pursuant to this paragraph shall include provisions guaranteeing the confidentiality of individually identifiable information. Within a reasonable period of time after the research for which the information was obtained has been completed, the data collected shall be modified in a manner so that the subjects cannot be identified, directly or through identifiers linked to the subjects.

(5) This section shall not operate to exempt from disclosure any information that is considered to be a public record pursuant to the California Public Records Act (Chapter 3.5 (commencing with Section 6250) of Division 7 of Title 1 of the Government Code) contained in an individual's file once an application for adjudication has been filed pursuant to Section 5501.5.

However, individually identifiable information shall not be provided to any person or public or private entity ~~who~~that is not a party to the claim unless that person identifies himself or herself or that public or private entity identifies itself and states the reason for making the request. The administrative director may require the person or public or private entity making the request to produce information to verify that the name and address of the requester is valid and correct. If the purpose of the request is related to pre-employment screening, the administrative director shall notify the person about whom the information is requested that the information was provided and shall include the following in 12-point type:

"IT MAY BE A VIOLATION OF FEDERAL AND STATE LAW TO DISCRIMINATE AGAINST A JOB APPLICANT BECAUSE THE APPLICANT HAS FILED A CLAIM FOR WORKERS' COMPENSATION BENEFITS."

Any residence address is confidential and shall not be disclosed to any person or public or private entity except to a party to the claim, a law enforcement agency, an office of a district attorney, any person for a journalistic purpose, or other governmental agency.

Nothing in this paragraph shall be construed to prohibit the use of individually identifiable information for purposes of identifying bona fide lien claimants.

(c) Except as provided in subdivision (b), individually identifiable information obtained by the division is privileged and is not subject to subpoena in a civil proceeding unless, after reasonable notice to the division and a hearing, a court determines that the public interest and the intent of this section will not be jeopardized by disclosure of the information. This section shall not operate to

~~November 15, 2011~~ (DATE TO BE INSERTED BY OAL - 6-12-6 MONTHS FOLLOWING APPROVAL AND FILING WITH SECRETARY OF STATE)

restrict access to information by any law enforcement agency or district attorney's office or to limit admissibility of that information in a criminal proceeding.

(d) It shall be unlawful for any person who has received individually identifiable information from the division pursuant to this section to provide that information to any person who is not entitled to it under this section.

DRAFT

Section E: Legal Authorities

Pertinent WCIS Regulations

The regulations pertinent to WCIS are stated in Title 8, California Code of Regulations, sections 9701-9704. They are available at http://www.dir.ca.gov/t8/ch4_5sb1a1_1.html.

~~WCIS Penalty Regulations~~

~~WCIS penalties upon approval will be stated in Title 8, California Code of Regulations, section 9705. Link to be determined upon approval.~~

All final WCIS regulations are posted at

http://www.dir.ca.gov/dwc/DWCPPropRegs/WCIS_Regs/WCIS_Regulations.htm.

Additional Regulations Related to Filing Employer’s First Reports of Injury

The regulations related to filing First Reports of Injury are stated in Title 8, **California Code of Regulations, sections 14001 and 14005**. They are available at <http://www.dir.ca.gov/t8/ch7sb1a1.html>.

Letter from DIR regarding electronic filing

(Note: The filing requirement for first reports of injury has been changed from five days to 10 days.)

February 7, 2000

To: California Workers’ Compensation Insurers and Self-Insured Employers

Re: Electronic Filing of the Employer’s Report of Occupational Injury or Illness (Form 5020)

Labor Code § 6409.1 and Title 8, California Code of Regulations (“C.C.R.”) Section 14001 require that both workers’ compensation insurers and self-insured employers file with the Division of Labor Statistics and Research (“DLSR”) a complete report of every occupational injury or illness that results in lost time beyond the date of injury or which requires medical treatment beyond first aid. The report must be filed within five days after obtaining knowledge of the injury or illness. Labor Code § 6409.1 (a); 8 C.C.R. § 14001 (d) & (e). 8 C.C.R. § 14001

~~November 15, 2011~~ (DATE TO BE INSERTED BY OAL – ~~6-12-6~~ MONTHS FOLLOWING APPROVAL AND FILING WITH SECRETARY OF STATE)

(c) provides that the mandatory filing shall be made by a photocopy of the Form 5020, the Employer's Report of Occupational Injury or Illness, or "by use of computer input media, prescribed by the Division and compatible with the Division's computer equipment."¹

Please be advised that DLSR hereby prescribes the Workers' Compensation Information System ("WCIS." See Labor Code § 138.6 and 8 C.C.R. §§ 9700-9704) as the "computer input media" referenced in 8 C.C.R. § 14001 (c). The obligation of an insurer or a self-insured employer to submit a complete report of occupational injury or illness pursuant to Labor Code § 6409.1 and 8 C.C.R. § 14001 is satisfied provided that the insurer or self-insured employer submits data to the WCIS as required under 8 C.C.R. § 9702 (b) and demonstrates capability to submit complete, valid, and accurate data under 8 C.C.R. § 9702 (h)(1). Assuming such data is electronically transmitted to the WCIS in an acceptable manner, claims administrators need not submit paper copies of the Form 5020 to DLSR.

Please note that specific information, or data elements ("DN"), required under 8 C.C.R. § 9702 (b) is not included on the Form 5020. For example, the Form 5020 does not include the employer's or insurer's Federal Employer Identification Number ("FEIN") (DN6 and DN16). Pursuant to 8 C.C.R. § 14005 (b) and (c), which allow insurers and self-insured employers to reproduce a revised Form 5020 to include additional questions, DLSR will approve the inclusion of questions asking for information necessary to comply with 8 C.C.R. § 9702 (b).

Thank you for your anticipated cooperation in this matter. Extensive information about the Workers' Compensation Information System, including a technical description of the prescribed computer input media, can be found on the Department's Web site at <http://www.dir.ca.gov/DWC/WCIS.htm>.

Any inquiries should be made to the Division of Workers' Compensation, Research Unit by e-mail at wcis@dir.ca.gov.

Sincerely,

Daniel M. Curtin
Chief Deputy Director
Department of Industrial Relations

¹ 8 C.C.R. § 14000 defines "computer input media" as "[t]echniques and means by which information or data can be entered into a computer system. Examples include magnetic tape, diskette, and telecommunications."
November 15, 2011 (DATE TO BE INSERTED BY OAL - 6-12-6 MONTHS FOLLOWING APPROVAL AND FILING WITH SECRETARY OF STATE)

Section F: Trading Partner Profile

Who Should Complete the Trading Partner Profile?

A separate Trading Partner Profile form should be completed for each Sender ID that will be used in EDI transmissions sent to WCIS. The Sender ID, which is composed of the trading partner's "Master FEIN" and physical address postal code (see profile form instructions), must be reported in the header record of every transmission. The Sender ID is used by WCIS to identify communication parameters as specified on the Trading Partner Profile form.

For many organizations, the claim administrator FEIN (Federal Employer Identification Number) provided on each transaction will always be the same as the Sender's Master FEIN. For EDI transactions, WCIS substitutes the Third Party Administrator FEIN (DN8), when applicable, for the claim administrator FEIN. If there is no Third Party Administrator, WCIS substitutes the Insurer FEIN (DN6) for the claims administrator FEIN and assumes that the insurer is administering the claim. Other organizations may have multiple claim administrator FEINs for their various operating units. If the transactions for these various claim administrator FEINs will all share the same transmission specifications, their data can be sent under the same Sender ID and be represented by a single Trading Partner Profile form.

For example, the information systems department of a single parent organization might wish to send transactions for two subsidiaries batched together within transmissions. In such a case, the parent organization could complete one Trading Partner Profile--providing the Master FEIN for the parent company in the Sender ID--and could then transmit transactions from both subsidiaries, identified by the appropriate claim administrator FEIN on each transaction.

The WCIS uses the insurer and claim administrator FEIN to process individual transactions. Transactions for unknown insurers and claim administrators will be rejected with the error code 039-No match on database. For this reason, it is vital for each WCIS Trading Partner Profile to be accompanied by a list of all insurer and claim administrator FEINs whose data will be reported under a given Sender ID. This list can be downloaded in Microsoft Excel format from the WCIS website at <http://www.dir.ca.gov/DWC/EDIVend.HTM> <http://www.dir.ca.gov/dwc/WCIS/InsurerClaimAdministratorIDList.xls>. If this ID list is not provided, WCIS will assume that the only claim administrator FEIN reportable by that trading partner will be the Master FEIN from the trading partner's Sender ID. The 9 digit postal code for the physical adjusting locations of each listed claim administrator must also be provided. These postal codes will be validated against incoming data and transactions with non-matching Claim Administrator Postal Codes (DN14) will be rejected with error code 032-Must be valid on zip code table. To prevent rejections, an updated ID list must be sent to your trading partner liaison each time there is a change.



**State of California
Department of Industrial Relations
DIVISION OF WORKERS' COMPENSATION**

FROI/SROI

ELECTRONIC DATA INTERCHANGE TRADING PARTNER PROFILE

The EDI Trading Partner Profile is available online at: <http://www.dir.ca.gov/DWC/WCIS.htm>.

PART A. Trading Partner Background Information:

Date: _____

Sender Name: _____

Sender's Master FEIN: _____

Physical Address: _____

City: _____ State: _____

Postal Code (Zip+4): _____ (Sender's postal code)

Mailing Address: _____

City: _____ State: _____

Postal Code: _____

Trading Partner Type (check any that apply):

- Self-Administered Insurer
- Self-Administered, Self-Insured (employer)
- Third Party Administrator of Insurer
- Third Party Administrator of Self-Insured (employer)
- Other (Please specify): _____

PART B. Trading Partner Contact Information:

Business Contact:

Technical Contact:

Name: _____ Name: _____

Title: _____ Title: _____

Phone: _____ Phone: _____

FAX: _____ FAX: _____

E-mail Address: _____ E-mail Address: _____

WCIS Reports Contact:

Name: _____

Title: _____

Phone: _____

FAX: _____

E-mail Address: _____

PART C. Trading Partner Transmission Specifications:

If submitting more than one profile, please specify:

PROFILE NUMBER (1, 2, etc.): _____

DESCRIPTION: _____

Part C1: TRANSACTION SETS FOR THIS PROFILE:

Transaction Type	File Format (circle one per row):		Expected Transmission Days of Week (circle any that apply):	Production Response Period
	Flat File Release #	ANSI X12 Version #		
First Reports of Injury	<u>1</u>	1 - Version 3041	Daily Mon Tues Weds Thurs Fri Sat Sun	3 business days
Subsequent Reports of Injury	<u>1</u>	1 - Version 3041	Daily Mon Tues Weds Thurs Fri Sat Sun	3 business days

PART C2: SFTP ACCOUNT INFORMATION:

User Name (8 characters max., alpha-numeric only) (To be provided by WCIS contact)	
Password (8 characters min.) (To be provided by WCIS contact)	
Transmission Mode (check one)	<input type="checkbox"/> SSL <input checked="" type="checkbox"/> SSL+PGP
Source Network IP Address (Only public IP addresses. Maximum 5 allowed.)	

File Naming Convention	
File Name Prefix (4 characters max.)	Unique Identifier (check one)
	<input type="checkbox"/> Sequence <input type="checkbox"/> Date/Time <input type="checkbox"/> Date/Sequence <input type="checkbox"/> Other _____

PART D. Receiver Information (to be completed by DWC):

Name: California Division of Workers' Compensation

FEIN: 943160882

Physical Address: 1515 Clay Street, Suite 1800

City: Oakland State: CA Postal Code: 94612-1489

Mailing Address: P.O. Box 420603

City: San Francisco State: CA Postal Code: 94142-0603

Business Contact:

Technical Contact:

Name: (Varies by trading partner)

Name: (Varies by trading partner)

Title: (Varies by trading partner)

Title: (Varies by trading partner)

Phone: (xxx) xxx-xxxx Phone: (xxx) xxx-xxxx

FAX: (510) 286-6862 FAX: (510) 286-6862

E-mail Address: wcis@dir.ca.gov

E-mail Address: wcis@dir.ca.gov

RECEIVER'S NETWORK IP ADDRESS FOR CONNECTING VIA FILE

TRANSFER PROTOCOL (SFTP): (Please contact DWC for this information)

RECEIVER'S FLAT FILE RECORD DELIMITER: CR

RECEIVER'S ANSI X12 TRANSMISSION SPECIFICATIONS:

Segment Terminator: <u>~</u>	ISA Information: <u>TEST</u> <u>PROD</u>
Data Elements Separator: <u>*</u>	Sender/Receiver Qualifier: <u>ZZ</u> <u>ZZ</u>
Sub-Element Separator: <u>></u>	Sender/Receiver ID: <u>(Use Master FEINs)</u>

PART E. California EDI Trading Partner Insurer/Claim Administrator ID List:

This Sender ID list is available online at: <http://www.dir.ca.gov/DWC/WCIS.htm>.
<http://www.dir.ca.gov/dwc/WCIS/InsurerClaimAdministratorIDList.xls>

Date Prepared: _____
 Sender Company Name: _____
 Sender E-mail Address: _____
 Sender Master FEIN: _____
 Sender Physical Postal Code (Zip+4): _____
 Trading Partner Type: _____ (refer to Trading Partner Types below*)

This list will be used to reconcile profile identification records. If, after filing this form with the Division, any entries are added or removed from the listing, the trading partner shall submit a revised California EDI Trading Partner Insurer/ Claim Administrator ID List.

List all insurer/claim administrator FEINs and claim administrator postal codes that will be reported by the Sender. **For each claim administrator, all physical adjusting locations must be listed separately.** Anytime there is a change, Trading Partners must submit a revised ID List.

#	Insurer/Claim Administrator/Self-Insurer Legal Name	FEIN #	Trading Partner Type*	Postal Code (Zip+4)**
1	Sender must be added to the list.			
2				
3				
4				
5				
6				
7				
8				
9				
10				
11				
12				
13				
14				
15				
16				
17				
18				
19				
20				

Please add additional lines and pages as needed.

***Trading Partner Types**

- 1 = Self-Administered Insurer
- 2 = Self-Administered, Self-Insured (employer)
- 3 = Third Party Administrator of Insurer
- 4 = Third Party Administrator of Self-Insured (employer)
- 5 = Other (Please specify): _____

****Nine-digit postal codes required for Claim Administrator Types 1-4. The FEIN and nine-digit postal code must match the DN6 or DN8 and DN14, respectively, submitted in your transmissions.**

WORKERS' COMPENSATION INFORMATION SYSTEM

Electronic Data Interchange Trading Partner Profile**INSTRUCTIONS FOR COMPLETING TRADING PARTNER PROFILE**

Each claims administrator will complete parts A, B, C and E, providing information as it pertains to them. Part D contains receiver information and will be completed by the Division of Workers' Compensation (DWC).

PART A. TRADING PARTNER BACKGROUND INFORMATION:

- Sender Master NAME:** The name of your business entity corresponding with the FEIN.
- Sender's Master FEIN:** The Federal Employer's Identification Number of your business identity. This FEIN, along with the 9-position zip code (Zip+4) in the trading partner address field, will be used to identify a unique trading partner.
- Physical Address:** The street address of the physical location of your business entity. It will represent where materials may be received regarding "this" trading partner agreement if using a delivery service other than the U.S. Postal Service.
- City:** The city of the physical address of your business entity.
- State:** The 2-character standard state abbreviation of the state of the physical address of your business entity.
- Postal Code:** The 9-position zip code of the physical address of your business entity. This field, along with the Trading Partner FEIN, will be used to uniquely identify a trading partner.
- Mailing Address:** The mailing address used to receive deliveries via the U. S. Postal Service for your business entity. This should be the mailing address that would be used to receive materials pertaining to "this" trading partner agreement. If this address is the same as the physical address, indicate "Same as above".

Claims Administrator Type: administrator. Indicate any functions that describe the claims Administrator Type: administrator. If "other", please specify.

PART B. TRADING PARTNER CONTACT INFORMATION:

This section provides the ability to identify individuals within your business entity who can be used as contacts. Room has been provided for two contacts: business and technical.

The BUSINESS CONTACT should be the individual most familiar with the overall extract and transmission process within your business entity. He/she may be the project manager, business systems analyst, etc. This individual should be able to track down the answers to any issues that may arise from your trading partner that the technical contact cannot address.

The TECHNICAL CONTACT is the individual that should be contacted if issues regarding the actual transmission process arise. This individual may be a telecommunications specialist, computer operator, etc.

The WCIS REPORTS CONTACT is the individual that should be sent WCIS reports regarding compliance with DWC and WCIS reporting statutes and regulations.

BUSINESS/TECHNICAL/ The name of the contact.

REPORTS CONTACT:

Name

BUSINESS/TECHNICAL/ The title of the contact or the role that contact

REPORTS CONTACT: performs.

Title

BUSINESS/TECHNICAL/ The telephone number at which that contact can be

REPORTS CONTACT: reached.

Phone

BUSINESS/TECHNICAL/ If FAX facilities are available, the telephone number of

REPORTS CONTACT: the FAX machine to use for the contact.

FAX

BUSINESS/TECHNICAL/REPORTS CONTACT: If the contact can be reached via electronic mail, an e-mail address that may be used to send messages to this contact should be provided in this section.

PART C. TRANSMISSION SPECIFICATIONS:

This section is used to communicate all allowable options for EDI transmissions between the trading partner and DWC.

PROFILE ID: A number assigned to uniquely identify a given profile.

PROFILE ID DESCRIPTION: A free-form field used to uniquely identify a given profile between trading partners. This field becomes critical when more than one profile exists between a given pair of trading partners. It is used for reference purposes.

PART C1: TRANSACTION SETS FOR THIS PROFILE:

This section identifies all the transaction sets/report types described within the profile along with any options that DWC provides to the claims administrator for each transaction set.

TRANSACTION TYPE: Indicates the types of EDI transmissions accepted by DWC.

FILE FORMAT: DWC will specify below any FLAT FILE RELEASE #(s) and ANSI X12 VERSION #(s) which can be accepted for a given transaction set by DWC. The claim administrator should select ONE mode of transmission (flat file release # or ANSI X12 version #) from the alternatives specified. **NOTE:** WCIS will transmit acknowledgments using the acknowledgment format that corresponds to the format of the original transaction.

~~**EXPECTED TRANSMISSION DAYS OF WEEK:** Indicate expected transmission timing for each transaction type by circling the applicable day or days. Transmission days of week information will help DWC to forecast WCIS usage during the week. Note that DWC reserves the right to impose restrictions on a trading partner's transmission timing in order to control system utilization.~~

PRODUCTION RESPONSE PERIOD: DWC will indicate here the normal period of elapsed time within which a sending trading partner may expect to receive an acknowledgment for a given transaction type.

PART C2: SFTP ACCOUNT INFORMATION:

~~SENDER NAME: The name of your business entity corresponding with the Master FEIN.~~

~~USER NAME: Specify a user name, which will be used to identify the authorized claim administrator for access to the WCIS-hosted FTP server. User names should be 8 characters maximum in length (alpha-numeric only), with a suffix added to the user name according to your mode of transmission. The suffix for SSL users will be “@WCISSSL” and for PGP users, it will be “@WCISPGP”. The user name will be provided by the WCIS contact person. A suffix, “@WCIS FS”, will be added at the end of the username for logging into the WCIS FROI/SROI host, ~~eg. e.g.~~, “username@WCIS FS”. User names are not case-sensitive. If you do not provide a username and/or password, they will be generated by the DWC WCIS and sent to you.~~

~~PASSWORD: Specify a password, which will be used by the WCIS in combination with the user name to prevent data file submission by unauthorized parties. Passwords should be at least 8 characters in length, and may contain letters or numbers (but no spaces or other symbols). Passwords are case sensitive. If you do not provide a username and/or password, they will be generated by the DWC WCIS and sent to you.”. The password will be provided by the WCIS contact person.~~

~~TRANSMISSION MODES: Select one of the following transmission mode: FTP over SSL or FTP over SSL using PGP encryption and authentication.~~

~~SOURCE NETWORK IP ADDRESS: This The public Internet Protocol (IP) address that will be used for allowing access connecting to the WCIS SFTP server through our firewall to establish the SFTP connections between the claims administrator and DWC. A maximum of five static IP addresses is allowed.~~

~~FILE NAMING CONVENTION: Each sender shall use a unique file naming convention for their incoming files based on the file name prefix and a unique identifier, such as date/time or date/sequence.~~

PART D. RECEIVER INFORMATION (to be completed by DWC):

This section contains DWC's trading partner information.

Name: The business name of California Division of Workers' Compensation (DWC).

FEIN: The Federal Employer's Identification Number of DWC. This FEIN, combined with the 9-position zip code (Zip+4), uniquely identifies DWC as a trading partner.

Physical Address: The street address of DWC. The 9-position zip code of this street address, combined with the FEIN, uniquely identifies DWC as a trading partner.

Mailing Address: The address DWC uses to receive deliveries via the U.S. Postal Service.

Contact Information: This section identifies individuals at DWC who can be contacted with issues pertaining to this trading partner. The TECHNICAL CONTACT is the individual that should be contacted for issues regarding the actual transmission process. The BUSINESS CONTACT can address non-technical issues regarding the WCIS.

RECEIVER'S NETWORK IP ADDRESS FOR CONNECTING VIA SFTP (SSH (Secure Shell) FILE TRANSFER PROTOCOL (SFTP):DWC will provide the appropriate network IP (Internet Protocol) address.

RECEIVER'S FLAT FILE RECORD DELIMITER: This character is to be used by claims administrators to indicate the end of each physical record when submitting flat file transactions formatted according to the IAIABC proprietary standards.

RECEIVER'S ANSI X12 TRANSMISSION SPECIFICATIONS:

SEGMENT TERMINATOR: The character to be used as a segment terminator is specified here.

DATA ELEMENT SEPARATOR: The character to be used as a data element separator is specified here.

SUB-ELEMENT SEPARATOR: The character to be used as a sub-element separator is specified here.

SENDER/RECEIVER QUALIFIER: This will be the claims administrator's ANSI ID Code Qualifier as specified in an ISA segment. Separate Qualifiers are provided to exchange Production and Test data, if different identifiers are needed.

SENDER/RECEIVER ID: If the claims administrator can accept ANSI transmissions, this will be the ID Code that corresponds with the ANSI Sender/Receiver Qualifier (ANSI ID Code Qualifier) as specified in an ISA segment. Separate Sender/Receiver IDs are provided to exchange Production and Test data, if different identifiers are needed.

PART E. ELECTRONIC PARTNERING INSURER/CLAIM ADMINISTRATOR ID LIST

This ID List includes all insurers and claim administrators whose data will be reported under a given Sender ID. The ID List includes insurer and claim administrator names, FEINs, claim administrator postal codes and trading partner types. For each claim administrator, all physical adjusting locations must be listed separately. Anytime there is a change, Trading Partners must submit a revised ID List.

Section G: Test, Pilot, Parallel and Production Phases of EDI

Test, Pilot, Parallel and Production Phases of EDI

This section is a step-by-step guide to become a successful EDI Trading Partner in the California workers' compensation system. Attaining EDI capability can be viewed as a ~~five~~ four step process: 1) begin with completing a Trading Partner Profile, 2) send a test transmission to make sure your system and the WCIS system can communicate with each other, 3) complete a Pilot phase, to check for complete, valid, and accurate data, 4) ~~(optional) complete a Parallel phase, where your EDI transmissions are compared to their corresponding paper reports and~~ 5) attain and maintain full production capability. The steps outlined below are meant to help you through this process by providing you with information on what to expect in terms of electronic acknowledgments, what could go wrong along the way, and how to fix problems as they arise. Your WCIS contact person is available to work with you during this process to make sure that the transition to attaining Production status in California workers' compensation EDI is as successful as possible.

Step 1. Complete an EDI Trading Partner Profile

Completing a Trading Partner Profile form is the first step in reporting workers' compensation EDI data to WCIS. As stated in the WCIS regulations (Section 9702(j)), the form should be submitted to the Division ~~at least 30 days before the first transmission of EDI data~~ at least 30 days before the Trading Partner sends the first test transmission of EDI data (see Step 2). See Section F of this guide for details on who should complete a Trading Partner Profile form.

1. Get a copy of the Trading Partner Profile form

Form DWC WCIS TP01 (Revised November 15, 2011) entitled *Electronic Data Interchange Trading Partner Profile*, is available from the following sources:

- Section F—Trading Partner Profile.
- California Division of Workers' Compensation web site at <http://www.dir.ca.gov/DWC/wcis.htm>
<http://www.dir.ca.gov/dwc/WCISenews/TradingPartnerProfile.pdf>
- Call or e-mail your WCIS liaison--see Section B—Where to Get Help.

When contacting us, please provide your name, company, and the e-mail or mailing address you would like the form sent to, and we will mail you a copy.

2. Complete the form

The form contains instructions about how to complete it. If you need additional help completing the form, contact your WCIS liaison. The Trading Partner Profile form asks you to provide the following information:

- Your business name, FEIN, 9-digit physical postal code, address, and type of business (insurer, employer, TPA, etc.)
- Name, phone, fax, and e-mail of business contact person
- Name, phone, fax, and e-mail of technical contact person
- Transmission mode
- Transmission specifications for each transaction type (flat file or ANSI X12)
- Transmission schedule (how often, what days)

Complete a list of all company names, FEINs and nine-digit postal codes of adjusting locations (DN14) for claim administrators whose data will be reported under the Sender ID of the Trading Partner profile (see Section F, Part E for more information). The WCIS uses the claim administrator FEIN to process individual transactions. Since transactions for unknown claim administrators will be rejected by WCIS, it is imperative that this information be provided along with the Trading Partner Profile form.

3. Return the completed forms to the Division

E-mail the Trading Partner Profile form and, if applicable, the sender ID list of claim administrator names, FEINs and postal codes reported under that Profile to the attention of your WCIS contact person or to wcis@dir.ca.gov.

4. Wait for approval of your Trading Partner Profile

- Your WCIS contact person will review your Trading Partner Profile and Sender ID list for completeness and accuracy. If there are any questions, you will be notified.
- Upon approval of your application, you will be notified. You are now ready to move into the Test phase and may begin sending test files (see Step 2) to assess the capability of your system to send transmissions to WCIS.

Step 2. Complete the Test Phase

Purpose

The purpose of the Test phase is to make sure that your transmissions meet certain technical specifications. WCIS needs to be able to recognize and process your transmissions, and your system needs to be able to recognize and process transmissions from WCIS. The following are checked during the test:

- the **transmission mode** for both report and acknowledgment files is functional and acceptable for both receiver and sender
- the **sender ID** is valid and recognized by the receiver and vice versa
- the **file format** (ANSI X12 or flat file) matches the file format specified in the Trading Partner Profile of the sender and is structurally valid
- the **batch format** of files sent by the Trading Partner is correct, (i.e., each batch contains an appropriate header record, one or more transaction records, and a trailer record, and the number of records sent matches the number indicated in the trailer)

Order of Testing

The Test (Step 2) and Pilot (Step 3), ~~and Parallel (Step 4)~~ phases are done separately for each transaction type supported by WCIS:

- First Report of Injury (FROI)
- Subsequent Report of Injury (SROI)

You should be in Production with First Reports before testing and piloting Subsequent Reports. This is because the WCIS system will not be able to recognize your Subsequent Report transmissions unless it has already received the corresponding First Report.

Test Criteria

In order for your system and the WCIS system to communicate successfully, the following conditions must be met:

- No errors in header or trailer records
- Correct ANSI structure (if using ANSI)
- TP can receive electronic acknowledgment (AK1/824) reports

Test Procedure

Trading Partners should follow the steps given in “Data Transmission with File Transfer Protocol” in Section I –The FTP-SFTP (SSH (Secure Shell) File Transfer Protocol) Transmission Modes – before sending a test file.

1. Prepare a test file

Trading Partners send data to WCIS in **batches**. A batch consists of 3 parts:

- a header record which identifies the sender, receiver, test/production status, time and date sent, etc.
- one or more transactions (First Reports or Subsequent Reports)
- a trailer record which identifies the number of transactions in the batch

We suggest that the test file consist of one batch of 5 production-quality reports of unique claims, real or simulated. Each test file must have the Test/Production indicator (DN104) located in the Header record set to “T”.

For First Reports: Submit Original first reports (Maintenance Type Code “00”)

For Subsequent Reports: Submit Initial Payment reports (MTC “IP”)

Note: If you would like to send additional MTCs while testing, please let your WCIS contact person know so that the WCIS system can be set up to receive them. Annual Reports (MTC “AN”), are a type of subsequent report and need not be tested. If a Trading Partner successfully tests SROIs with MTC “IP,” then it automatically passes the Test phase for SROIs with MTC “AN.”

2. Send the test file

Send the test file to WCIS [and notify your trading partner contact](#). The test data you send, if successful, will be posted to our test database. They will not be posted to the WCIS production database. This means that any live California claims sent as test data will have to be resent to WCIS, after passing the test stage, in order to be posted to the WCIS production database.

3. Wait for electronic acknowledgment from WCIS

Trading Partners must be able to receive and process an electronic acknowledgment--AK1 (flat file) or 824 (ANSI)--from WCIS. When a test file has been processed, an electronic acknowledgment will be transmitted to the Trading Partner. The acknowledgment will report whether the transmission was successful, and, if not successful, any errors that occurred, as outlined in the following table.

Note that if the test file is missing the header, or if the sender ID in the header is not recognized by WCIS, no acknowledgment will be sent.

Also, the acknowledgment sent during the test phase will be header-level only; it will not contain information about the individual claims that you sent.

Structural Edits

Error Code, if applicable	Message	Edit	Result
		Presence <u>Absence</u> of HD1 (Header record)	Transmission rejected; no ACK sent
042	<u>Not Statutorily Valid</u>	Presence <u>Absence</u> of TR1 (Trailer record)	ACK rejecting transmission
002	<u>Not Statutorily Valid</u>	Transaction Set ID at record level invalid	ACK rejecting transmission
997 Error Codes		ANSI structure validation <ul style="list-style-type: none"> • Segment Count does not match • Transaction Set Trailer Missing • Transaction Set not Supported • Transaction Set Control # in Header/Trailer don't match • Missing or Invalid Transaction Set ID • Missing or Invalid Transaction Set Control # 	997 functional acknowledgment
042	<u>Not Statutorily Valid</u>	Header record must be 87 bytes long	ACK rejecting transmission
<u>042</u>	<u>Not Statutorily Valid</u>	FROI X148 record must be <u>913</u> bytes long	ACK rejecting transmission
<u>042</u>	<u>Not Statutorily</u>	SROI A49 record must not be less	ACK rejecting

	<u>Valid</u>	<u>than 208 bytes long</u>	<u>transmission</u>
<u>042</u>	<u>Not Statutorily Valid</u>	<u>Trailer record must be 12 bytes long</u>	<u>ACK rejecting transmission</u>

Data Edits

Error Code	Message	Data Elements to Validate	Result
001	Trading Partner Table Mandatory field not present	<ul style="list-style-type: none"> Sender ID Receiver ID Date Transmission Sent Time Transmission Sent Test/Production Indicator Interchange Version ID 	Transmission rejected; no ACK sent (Sender ID) ACK rejecting transmission (remaining elements)
028	Must be Numeric (0-9)	<ul style="list-style-type: none"> Detail Record Count 	ACK rejecting transmission
029	Must be a valid Date (CCYYMMDD)	<ul style="list-style-type: none"> Date Transmission Sent 	ACK rejecting transmission
031	Must be a valid Time (HHMMSS)	<ul style="list-style-type: none"> Time Transmission Sent 	ACK rejecting transmission
039	No match on database	<ul style="list-style-type: none"> Sender Id 	Transmission rejected; no ACK sent
041	Must be <= Current Date	<ul style="list-style-type: none"> Date Transmission Sent 	ACK rejecting transmission
056	Detail Record Count NE count not equal to the number of res records received	<ul style="list-style-type: none"> Detail Record Count 	ACK rejecting transmission
057	Duplicate Transmission	<ul style="list-style-type: none"> Transaction Set ID 	ACK rejecting transmission
058	Code/ID Invalid	<ul style="list-style-type: none"> Test/Production Indicator Interchange Version ID Receiver ID 	ACK rejecting transmission
058	Code/ID Invalid	<ul style="list-style-type: none"> Release Number = 1 	ACK rejecting transmission
<u>042</u>	<u>Not Statutorily Valid</u>	<ul style="list-style-type: none"> For all flat file data fields, only the following ASCII characters are allowed: A...Z a...z 0...9 , < . > / ? ; : " [{ } \ ` ~ ! @ # \$ % ^ & * () - _ = + (space) 	ACK rejecting transmission

Trading Partners should receive an electronic acknowledgment within 3 business days 48 hours of sending the test transmission. If you do not receive an acknowledgment within 5 business days 48 hours, contact your WCIS contact person.

Trading Partners using ANSI X12 file format will receive a 997, or functional acknowledgment, in addition to the 824.

4. Process the acknowledgment and correct any errors

If you receive an acknowledgment error (Acknowledgment Transaction Set ID (DN110) = HD1 and Application Acknowledgment Code (DN111) = TR or “transaction rejected”), you will need to check the batch’s file format, and make corrections before re-transmitting the file to WCIS.

If the acknowledgment has a TA code (“transaction accepted”), skip to step 6.

5. Retransmit corrected file to WCIS

Send the corrected file to WCIS. If your test fails again, repeat steps (2) through (5) until your test file is accepted by WCIS (no TR code). You may send as many test files as you need to. Let your WCIS liaison know if you have any questions or problems along the way.

6. Notify the Division when you are ready to move on to the Pilot Phase

When WCIS accepts your test transmission without technical errors, this means that your system and the WCIS system are able to successfully communicate with each other and your files are in a format readable by WCIS. Let your WCIS liaison know when you have successfully transmitted a test file. This person will verify the success of your test by accessing the WCIS system. If you have passed, your Trading Partner Profile on the WCIS system will be updated to prepare WCIS for your pilot data.

Your WCIS liaison will notify you when the WCIS system is ready to accept your pilot data. You may then begin transmitting pilot data as described in Step 3 below.

Step 3. Complete the Pilot Phase

Overview

During the Pilot phase, the Trading Partner sends live California workers’ compensation injury reports--First Reports of Injury and/or Subsequent Reports of Injury--to WCIS to be analyzed for data validity and completeness. The Test/Production Indicator (DN104) should be set to “P” at this point.

Purpose

Testing for data quality during the Pilot, ~~Parallel~~ and Production phases will help Trading Partners comply with Section 9702, Electronic Data Reporting of the WCIS Regulations (8 CCR §9702(a)):

“Each claims administrator shall, at a minimum, provide **complete, valid, and accurate data** for the data elements set forth in this section.”

- **complete data** – In order to evaluate the effectiveness and efficiency of the California workers’ compensation system (one of the purposes of WCIS set forth in the 1993 authorizing statute), claims administrators must submit all required data elements on workers’ compensation claims for the required reporting periods. Completeness of FROI and SROI reporting by claim administrators will be validated against the aggregated counts submitted to the DWC Audit Unit’s Annual Report of Inventory (ARI).
- **valid data** – Valid means that the data are what they are purported to be. For example, data in the date of injury field must be date of injury and not some other date (or something else entirely). Data must consist of allowable values, e.g., date of injury cannot be September 31, 2005, a non-existent date. At a more subtle level, each Trading Partner must have the same understanding of the meaning of each data element and submit data with that meaning only. **Review the definitions for each required data element in the *Data Dictionary of the IAIABC EDI Implementation Guide* (<http://www.iaabc.org>) to be sure that your use of the data element matches that assigned by the IAIABC. If your meaning or use of a data element differs, you will need to make changes to conform to the IAIABC standards.**
- **accurate data** – Accurate means free from errors. There is little value in collecting and utilizing data unless there is assurance that the data are accurate. WCIS edits are based on ~~currently follows~~ the IAIABC Edit Matrix error messages in the February 15, 2002 revised edition of the *IAIABC EDI Implementation Guide*.

The Pilot phase is used to ensure that the above requirements are met before a Trading Partner is allowed to routinely submit electronic data to WCIS ~~in the place of hard copy reports--in other words, before the Trading Partner is moved to Parallel status.~~

Data Quality Criteria

Reports are first transmitted to WCIS via EDI, and they are tested for **completeness** and **validity** using automatic built-in data edits on the WCIS system.

DWC suggests that you transmit **at least 30 live claims** to WCIS. These claims should meet or exceed the following two data quality criteria:

- No more than 5% of transmitted reports are rejected (Application Acknowledgment Code = TR or “transaction rejected”). This is the same as saying that at least 95% of transmitted reports are free of any errors in mandatory/fatal or conditional/fatal data elements, AND
- Of the ~~accepted reports~~ accepted ($\geq 95\%$ of transmitted reports), ~~no more than 105% contain errors (Application Acknowledgment Code = TE or “accepted with errors”) (Application Acknowledgment codes TA and TE), no more than 5% can be TE (Application Acknowledgment code = TE)."~~ no more than 5% can be TE (Application Acknowledgment code = TE)." This is the same as saying that at least 90% 95% of the accepted reports are free of any errors in mandatory/serious or conditional/serious data elements.

Note: Trading Partners whose claim volume is too low to reasonably send 30 claims may send fewer claims. Your WCIS contact will be able to advise you on how many claims to send.

First Reports: If data do not meet the above data quality criteria on the initial submission because of missing data, the Trading Partner has up to 60 days from the initial submission to fill in missing data in order to meet these criteria (see section 9702(b) of the WCIS regulations). Any corrections made will be reflected in the remainder of the pilot process.

The data reporting requirements for each data element are listed in Section K – Required Data Elements.

Transactions that are rejected (TR) must be corrected and resent with the original MTC code of the rejected transaction. Transactions that are accepted with error (TE) must be corrected and resent with the CO (Correction) MTC code.

Test/Production Indicator

The Test/Production indicator (DN104) located in the Header record is set to “P” during the Pilot stage. Data are posted to the California WCIS live database.

Maintenance Type Codes Piloted

The following are the maintenance type codes piloted in California at this time:

FROI	00	(Original)
SROI	IP	(Initial Payment)

During the Pilot process, Trading Partners may also need to submit reports with MTC CO (Correction) in order to correct data reported in error or to fill in missing data. Trading Partners may also submit reports with MTC 02 (Change) to update any previously reported data elements that were accepted without error.

After a report type has been successfully piloted, all other maintenance type codes for that report type become reportable. For example, once a Trading Partner has successfully piloted Original First Reports, the AU, 01, 04, 02, and CO maintenance type codes for first reports are reportable. Depending on overall Trading Partner performance, California may later choose to incorporate additional maintenance type codes into the piloting requirements.

Step 4. Parallel Procedure (Optional)

1. Request Parallel analysis

After you have fulfilled the completeness and validity data quality requirements of EDI, the next step is to submit the paper reports of the corresponding EDI reports to be cross-checked for accuracy. Notify your WCIS contact person when you are ready for a "Parallel analysis". This person will verify that the EDI completeness and validity requirements are fulfilled before you proceed.

Unresolved mismatches between the paper and EDI reports should not exceed 5% of all reportable data elements across all cross-checked reports. In addition, there may be no data mapping errors (e.g., employer telephone number always sent in place of the employee telephone number, or "part of body = foot" always sent when "part of body = hand").

A cross-walk of data elements contained on California First Report Forms 5020 and 5021 and on the EDI First Report of Injury is provided at the end of this section. For data elements that appear on all three reports, a match on the EDI First Report with at least one of the corresponding values from the paper reports is required. For example, if the employer address field is filled in on Form 5020 but not on Form 5021, the address on Form 5020 should match the corresponding EDI data elements for employer address. If different employer addresses are provided on Forms 5020 and 5021, one of these addresses should match the corresponding EDI data elements for employer address.

Additionally, the following data elements are used in the Parallel analysis:

DN	Data Element
44	Employee First Name
43	Employee Last Name
45	Employee Middle Name/Initial
46	Employee Street Address Line 1
48	Employee City
49	Employee State
50	Employee Postal Code
51	Employee Phone Number
42	Social Security Number
52	Employee Date of Birth
53	Gender Code
61	Date of Hire
59	Class Code
58	Employment Status Code
60	Occupation
18	Employer Name
19	Employer Street Address Line 1
21	Employer City
22	Employer State
23	Employer Postal Code
62	Wage
63	Wage Period
31	Date of Injury
65	Date Last Day Worked
56	Date Disability Began
35	Nature of Injury Code
36	Part of Body Injured Code
37	Cause of Injury Code
38	Accident Description/Cause
33	Postal Code of Injury Site
68	Date of Return to Work
57	Employee Date of Death
40	Date Reported to Employer

2. Prepare paper copies of reports

~~First Reports: Make one copy of completed Form 5020, Rev. 6, Employer's Report of Occupational Injury or Illness for each Original First Report that you submitted in the EDI portion of the pilot. If you wish, you may also make one copy of Form 5021, Rev. 4, Doctor's First Report of Occupational Injury or Illness. This gives you more opportunities for a successful match if information on Form 5020 fails to match the EDI First Report. Fill out a WCIS Parallel Batch Identification Form (at the end of this section). The purpose of this form is to allow DWC to link your EDI reports to your paper reports.~~

~~Subsequent Reports (IP): Make one copy of the benefit notice sent to the employee notifying him/her of the start of benefit payments for each Subsequent Report that you submitted in the EDI portion of the Pilot. Fill out a WCIS Parallel Batch Identification Form (at the end of this section). This form allows DWC to link your EDI reports to your paper reports.~~

3. Send paper reports to DWC

~~Send the paper forms to your WCIS liaison. Please include a completed WCIS Parallel Batch Identification Form to facilitate identification of your claims. Mail the entire packet to:~~

~~WCIS Parallel Phase
Attn: Your WCIS Contact
Department of Industrial Relations
1515 Clay St, Suite 1800
Oakland, CA 94612~~

4. Wait for Parallel Analysis Report

~~Your WCIS contact will compare your paper and EDI reports for consistency and prepare a "Parallel Analysis Report," which will be sent to you. The report will describe any discrepancies noted between data sent on paper and data sent electronically, as well as any other suspected data issues/errors not detected by the routine EDI program edits.~~

~~You may be asked to explain any discrepancies. Depending on the extent of the discrepancies, this may require a phone consultation, a meeting, a brief note, or a more formal written justification.~~

Moving from Parallel to Production Status

~~When the data quality criteria of the Pilot and the optional Parallel phase have been met for a given transaction, the Trading Partner will be approved for Production status for that transaction. You will receive written authorization from the Division to submit Production status data to WCIS for the transaction type successfully tested and piloted. Once Production status for a transaction type has been granted, you will no longer be required to send the corresponding paper report to the Division of Labor Statistics and Research (DLSR).~~

Step 45. Production

Congratulations! You are now officially in Production for EDI reporting of workers' compensation claims data with the State of California Division of Workers' Compensation.

During Production, the following conditions apply:

Paper Reports

The EDI First Report fulfills the requirement to submit paper copies of the Employer's Report (Form 5020) to the California Division of Labor Statistics and Research (DLSR), pursuant to Labor Code §6409.1 and 8 C.C.R. §14001 (see letter from DLSR in Section E–WCIS Regulations). However, the submission of paper copies of the Doctor's First Report of Occupational Injury or Illness (Form 5021) to DLSR is still required at this time (LC §6409 and 8 C.C.R. § 14001-14002).

In the future, submission of the ICD-9 CM Diagnosis Code, on the first Medical Bill/Payment Report, may substitute for the requirement to submit the paper Doctor's First Report (Form 5021) to DLSR.

Trading Partners in Production status for Subsequent reports satisfy the obligation to submit paper copies of benefit notices to the Administrative Director pursuant to Labor Code §138.4 (see §9702 (h)(1) of the WCIS regulations).

Data Completeness and Accuracy Quality Requirements

Data sent to WCIS will continue to be monitored for completeness and validity. The following are guidelines for data quality that Trading Partners should strive to meet or exceed:

At least 95% of all required FROI and SROI reports should be submitted on-time and accurately.

- For FROI reports \geq 95% of FROI s should be should be submitted and accepted (Application Acknowledgment codes TA or TE), within 10 business days of the Date Reported to Claim Administrator (DN 41). For SROI reports \geq of SROIs should be submitted within 15 business days of the triggering event.
- For FROI and SROI reports, At least 95% of transmitted reports should be free of any uncorrected errors in ~~mandatory/fatal and conditional/fatal~~ data elements, of the reports accepted (Application Acknowledgment codes TA and TE), no more than 5% should have an uncorrected TE (Application Acknowledgment code = TE)". This is the same as saying that at least 95% of the accepted reports are free of any errors in mandatory/serious or conditional/serious data elements.
- At least 90% of accepted reports should be free of any errors in ~~mandatory/serious and conditional/serious~~ data elements.

Note: As in the Pilot phase, these requirements need not be met upon the first submission of data to WCIS. Trading Partners have up to 60 days after the first submission of First Report data to submit data elements that were omitted on the first transmission because they were not known to the claims administrator (see Section 9702(b). Electronic Data Reporting of the WCIS Regulations). Notwithstanding this requirement, the claims administrator is required to transmit data in response to a data error message generated by WCIS, or when the claims administrator becomes aware of the need to update data elements previously transmitted or omitted, no later than the next submission of data for the affected claim (see Section 9702(f) of the WCIS Regulations).

DWC anticipates that, in the future, its claims auditors will collect data from claims administrators. These data will be checked for data accuracy against EDI data that were already submitted to WCIS (see LC §129; 8 CCR §10105).

Data Quality Reports

November 15, 2011 (DATE TO BE INSERTED BY OAL - 6.12 MONTHS FOLLOWING APPROVAL AND FILING WITH SECRETARY OF STATE)

WCIS automatically monitors the quality of data received from Trading Partners during the Pilot and Production phases. The system tracks all outstanding errors and produces automated data quality reports. The Division provides data quality reports to each Trading Partner upon request.

Trading Partner Profile

Trading Partner Profiles and Claims Administrator ID Lists must be kept up-to-date. The Division must be notified of any changes to the Trading Partner Profile and Claims Administrator ID Lists, since these may affect whether WCIS recognizes your transmissions.

WCIS PARALLEL BATCH IDENTIFICATION FORM

TO: _____
_____ WCIS Contact

FROM: _____ TRADING PARTNER (the following information must be as it appears on your Trading Partner Profile)

NAME _____

ADDRESS _____

FEIN _____ ZIP CODE _____

DATE(S) ELECTRONIC TRANSMISSION(S) WERE SENT _____

TOTAL NUMBER OF EDI CLAIMS SENT _____

DATE PAPER REPORTS MAILED _____

NUMBER OF PAPER REPORTS MAILED _____

PREPARED BY _____

PHONE _____

COMPLETE THIS FORM AND RETURN WITH COPIES OF PAPER 5020 (and 5021 REPORTS, if desired) OR NOTICES OF INITIAL BENEFIT PAYMENTS TO:

**WCIS Parallel Phase
Attn: WCIS Contact
Department of Industrial Relations
1515 Clay St, Suite 1800
Oakland, CA 94612**

Section H: File Formats and Supported Transactions

Supported Transactions

The WCIS accepts transactions in the IAIABC Release 1 format. Since the IAIABC no longer supports the Release 2 format, WCIS does not accept Release 2 transactions.

Understanding ANSI and Flat Files

The IAIABC has approved two file formats for the electronic submission of Release 1 transactions: ANSI X12 formats – based on the American National Standards Institute (ANSI) X12 EDI standard – and proprietary IAIABC “flat file” formats.

First Reports	ANSI X12 Release 1 (Version 3041) IAIABC Flat File Release 1
Subsequent Reports	ANSI X12 Release 1 (Version 3041) IAIABC Flat File Release 1

ANSI X12 is the primary EDI standard for electronic commerce in a wide variety of applications. Data elements are strung together continuously, with special data element identifiers and separator characters delineating individual data elements and records. ANSI X12 is extremely flexible but also somewhat complex, so most X12 users purchase translation software that handles the X12 formatting. Because X12 protocols are used for many types of business communications, X12 translation software is commercially available. Some claim administrators may already be using X12 translation software for purchasing, financial transactions, or other business purposes.

The IAIABC’s proprietary flat file formats were designed specifically for transferring workers’ compensation data via EDI. Data elements are placed in assigned character positions within each record. Different records are presented on separate lines of the file. Flat files have the disadvantage of being inflexible and not easily modified. The Release 1 version of the flat files is fairly straightforward to implement without translation software.

Section I: The SFTP (SSH (Secure Shell) File Transfer Protocol) Transmission Modes

File Transfer Protocol (FTP) SFTP (SSH (Secure Shell) File Transfer Protocol)

Trading partners will send all data files to an ~~FTPS (FTP over SSL, RFC4217)~~ SFTP server hosted by the WCIS. An encrypted transmission tunnel is established during SFTP transfer to ensure data security. Trading partner log in will be authenticated through username, password, SSH key exchange, and source IP address verification. Acknowledgments will be retrieved from the same server. Use of FTPS to encrypt the network connection is required. In addition, trading partners may optionally use PGP (Pretty Good Privacy, RFC4880) to encrypt the files before transmission. A history of the PGP program and frequently asked questions is available at <http://www/pgpi.org>.

Data Transmission with File Transfer Protocol SFTP (SSH (Secure Shell) File Transfer Protocol)

Certain processes and procedures must be coordinated to ensure the efficient transmission of data and acknowledgment files via SFTP.

Step 1. Trading Partner Profile

Complete the Trading Partner Profile form in section F – trading partner profile. The WCIS SFTP IP host address will be provided to trading partners by their trading partner contact person. After the Trading Partner Profile form is completed, follow the steps below.

Step 2. FTP SFTP (SSH (Secure Shell) File Transfer Protocol) user account and password

The WCIS SFTP server requires a user account and password for access. The account and password is entered in Part C2 on the trading partner profile form will be provided by the WCIS. The suffix, “@WCIS_FS”, must be added to the username, e.g., “username@WCIS_FS”. After establishing connectivity, the trading partner may must change the password every 90 days. Password changes and resets must be coordinated with the trading partner contact. User accounts will be locked out after three unsuccessful logon attempts. The SSH key exchange will be coordinated by your WCIS contact.

Step 3. WCIS SFTP (SSH (Secure Shell) communication ports

The WCIS SFTP server requires the following communications ports 22 to be opened for SFTP transmissions: 20, 21, 989, and 1024-1224. The ports 1024 and above are used as data channels. The high-numbered ports are assigned sequentially by the server per session.

Step 4. FTP over SSL (FTPS)

The WCIS FTP server requires “explicit” security for negotiating communication security for data transfer for SSL. Explicit security supports the “AUTH SLL” “AUTH SSL” security command. The WCIS FTP server software (i.e. WS_FTP Server) only supports the “explicit” security.

The WCIS FTP server uses “passive” mode for transferring data. The server waits for the data connection from the trading partner’s FTP client software to initiate the data transfer process.

The WCIS FTP server address will be provided to trading partners by their trading partner contact person. The WCIS server uses a private root certificate for SSL encryption. When a trading partner establishes connectivity with the WCIS FTP server, its private certificate is exchanged. Some FTP client software (e.g. WS_FTP, Cute FTP, Smart FTP, and Core FTP) acknowledge the private certificate while others do not. If the certificate is not recognized, the trading partner will need to obtain the WCIS FTP server’s root certificate from their trading partner contact person and import it into their system.

Step 4. Trading partner source IP address

Access to the WCIS SFTP server will be restricted to static source IP addresses that are entered on the trading partner profile form. Trading partners may provide up to ~~two~~ five source IP addresses. The source IP addresses must be public addresses. Although some network systems use private addresses for internal networks (e.g.; 10.0.0.0, 172.16.0.1 and 192.168.1.1), WCIS will require the public IP address that the private addresses translate to. Trading partners must notify their trading partner contact when a source IP address has changed.

Step 5. Testing SFTP connectivity

The WCIS trading partner contact and the trading partner will coordinate testing SFTP connectivity. Trading partners will be asked to send a plain text test file for testing. The test file should not may contain data, but a simple test message it will not be processed in the production database. The file should be named “test.txt” and placed in the trading partner’s root directory of the WCIS FTP server. A test acknowledgment file will be left in the trading partner's AK1 folder. After testing is complete, the transmission of production files will be coordinated.

Sending data Through SFTP

Trading partners will send production data files to the WCIS SFTP server by placing them in a directory named “FS_Production~~Inbound~~”. Test files should be sent to the “FS_Test” folder. The contents of the directory are not visible by the trading partner. Files cannot be deleted by the trading partner after they have been uploaded. Transmission errors will be generated by the trading partner’s FTP program or process.

File names must be unique and follow file naming conventions prescribed below. An error will occur when a file with the same name as an existing file is uploaded to the ~~Inbound~~ directory of the WCIS SFTP server.

Receiving acknowledgment files through SFTP

WCIS will place functional (997), for ANSI formatted data, and detailed acknowledgment files (824 or AK1) on the WCIS SFTP server in the trading partners’ ~~997 and 824 folders~~ AK1 folder. Acknowledgment files will follow the naming convention, A*.TXT. The acknowledgment response period for production files is 3 business days. Trading partners may delete acknowledgment files after they have retrieved the files. WCIS will periodically review contents of the trading partner’s directory and may delete unauthorized user folders and files older than 14 days old.

File naming conventions

~~The file naming conventions will be based on a unique 4 letter file name prefix and one or more unique identifiers, such as date and sequence number. File names must be unique and cannot contain spaces. The specific file naming conventions will be specified by each trading partner in Part C2 of the trading partner agreement and must be approved by the DWG.~~

Naming convention:

Files must start with the three character file type, 148, A49, or AK1, followed by an underscore “.”

The 5th through 13th characters are the Trading Partner’s Sender FEIN followed by an underscore “.”

The 15th through 23rd characters are the Trading Partner’s 9 digit Sender zip code followed by an underscore “.”

The 25th through 32nd characters are the Date Stamp of the 148, A49, or AK1 file (8-digit date, CCYYMMDD) followed by an underscore “.”

The 34th through 39th characters are the Time Stamp of the 148, A49, or AK1 file (6-digit time, HHMMSS) followed by an underscore “.”

The 41st character is the test/ production indicator: a “T” for Test or a “P” for Production followed by an underscore “ .”

The 43rd through 45th character are a unique 3 digit counter (001-999) for 148 and A49 files, and the 43rd through 51st characters are a unique 9 digit counter for AK1 files.

All files will be named with a .txt extension. Files with any other file extensions will not be processed.

148 file name example:

148 123456789 946125698 20140113 135012 T 001.txt

A49 file name example:

A49 123456789 946125698 20140113 135012 T 001.txt

AK1 file name example:

AK1 123456789 946125698 20140113 135012 T 000602101.txt

An error will occur when a file is submitted with the same name of a file that already exists in the WCIS folder.

Sending data using PGP encryption

Trading partners who choose to send PGP encrypted data to the WCIS FTP server should follow steps 1-5 and exchange PGP keys with the WCIS before sending data. The PGP program is encryption software available from PGP Corporation (<http://www.pgp.com>) and the International PGP home page (<http://www.pgpi.org>). PGP is also available from previous versions of security programs offered by Network Associates (<http://www.nai.com>), which had previously acquired the license to distribute PGP.

If the Trading Partner does not already have a PGP key, it will need to generate its own unique set of PGP keys. The PGP program will create a set of public and private keys based on information you enter into the program. The PGP public keys are required for encryption to provide data security. Data sent to WCIS is encrypted by WCIS's public key and files are signed by the Trading Partner's private key. The exchange of public keys ensures that the recipient is the only one that is able to read the file and that the sender is the only one that could have sent the data. Please do not share private keys and passwords with anyone else as this would allow others to create files that would appear to have come from you.

Transmission Pathways

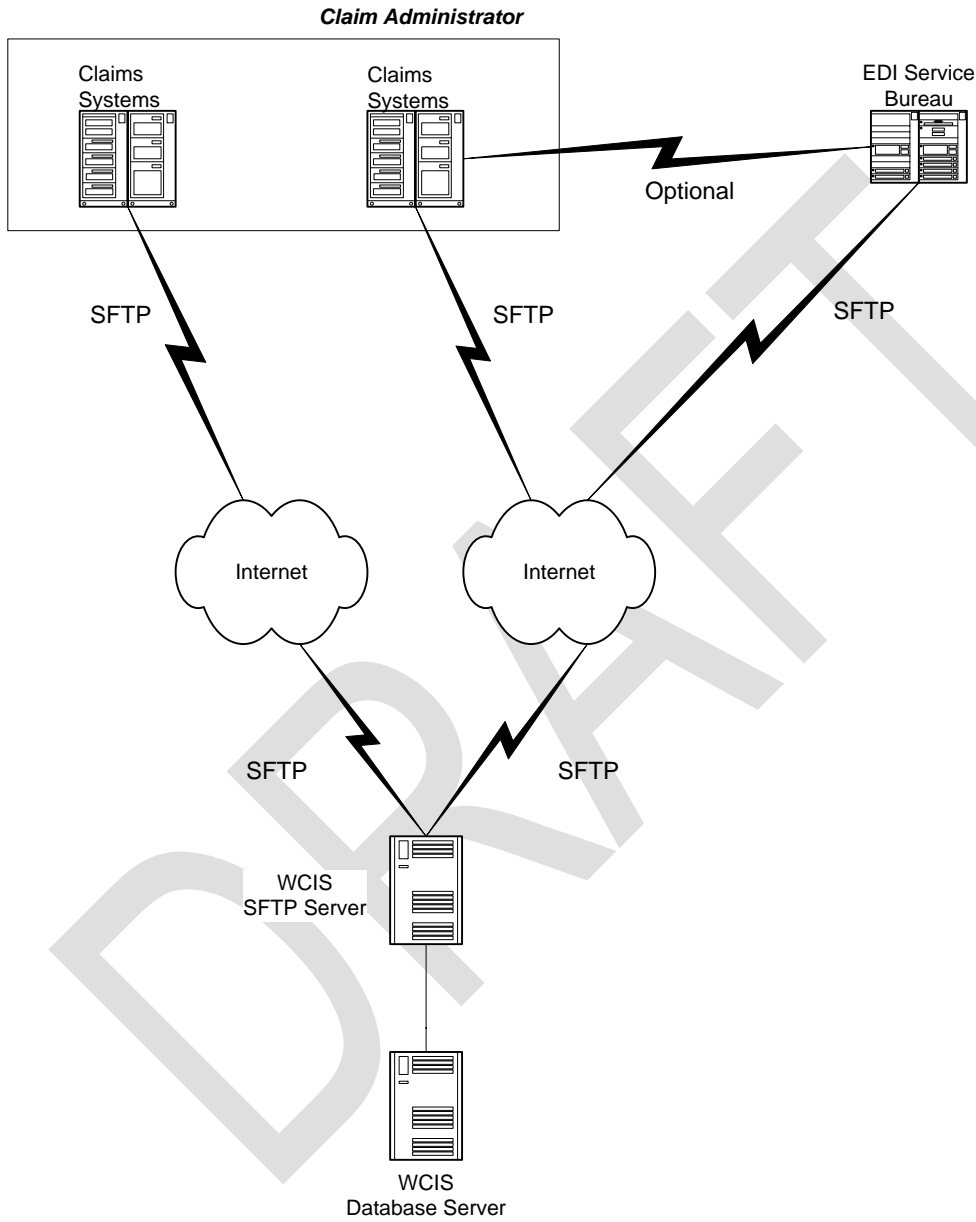

Section J: Events that Trigger Required EDI Reports

Release 1

First Report of Injury

For claims with date of injury March 1, 2000 or later.

MTC [†]	Event	Time Report is Due
00	A new Employer's Report OR A new Doctor's First Report of Injury OR An Application for Adjudication OR Information that an injury requires medical treatment by a physician.	Within 10 business days (report all data known to the claims administrator)
01	A previously sent First Report was sent in error.	Within 10 business days of event
02	Previously sent First Report was incomplete.	Within 60 days of original first report submission
02	Data in previous First Report have changed.	By next date a submission is due for the claim
AU	Claim acquired from another claims administrator.	Within 10 business days of event
CO	Correction of previously reported data, in response to a TE (transaction accepted with error) acknowledgment.	By next date a submission is due for the claim <u>Within 30 60 calendar days of original TE acknowledgment</u>
04*	Denial of Claim and no benefits were paid.	Within 10 business days of event

[†]MTC is the Maintenance Type Code and is included in all EDI transactions to identify the type of transaction that is being reported. Definitions and technical specifications for each MTC can be found in the IAIABC EDI Implementation Guide at <http://www.iaabc.org>.

* Claims identified as having no coverage upon knowledge of the claim need not be submitted to WCIS.

Release 1**Subsequent Report of Injury**

For claims with date of injury July 1, 2000 or later.

MTC [†]	Event	Time Report is Due
IP	Initial payment of an indemnity benefit.	Within 15 business days of event
AP	First payment of benefits on a claim acquired from another claim administrator.	Within 15 business days of event
FS	Employer is paying the injured worker's salary.	Within 15 business days of event
CD	Injured worker died because of a covered injury.	Within 15 business days of event
04	Claim is denied and benefits were paid, including medical.	Within 15 business days of event
4P	A specific benefit has been denied.	Within 15 business days of event
02	A previous benefit report has changed or Employee representation has changed. (Do not include changes in weekly benefit rates/ benefit type).	By next date a submission is due for the claim
CA	The weekly benefit rate has changed.	Within 15 business days of event
CB	Current benefit type is ending and a new benefit type is beginning <u>or</u> a concurrent benefit type is beginning.	Within 15 business days of event
RE	The injured worker may return to work with reduced earnings.	Within 15 business days of event
P1/S1 [*]	Employee returned to work, payments stopped.	Within 15 business days of event
P2/S2 [*]	There is a medical noncompliance, payments stopped.	Within 15 business days of event
P3/S3 [*]	There is an administrative noncompliance, payments stopped.	Within 15 business days of event
P4/S4 [*]	Employee died, payments stopped.	Within 15 business days of event
P5/S5 [*]	Employee is incarcerated, payments stopped.	Within 15 business days of event
S6	Employee's whereabouts unknown, payments stopped.	Within 15 business days of event
P7/S7 [*]	Benefits exhausted, payments stopped.	Within 15 business days of event
S8	Jurisdiction changed, payments stopped.	Within 15 business days of event
P9/S9 [*]	A settlement is pending, payments stopped.	Within 15 business days of event
PJ/SJ [*]	An appeal or review is pending, payments stopped.	Within 15 business days of event
RB	Benefits are being reinstated after a suspension.	Within 15 business days of event
PY ^Δ	An advance or settlement has been paid.	Within 15 business days of event
CO	Correction of previously reported data, in response to a TE (transaction accepted with error).	By next date a submission is due for the claim Within 30 <u>60</u> 30 calendar days of original TE acknowledgment
FN#	Claim is closed.	Within 15 business days of event

[†]MTC is the Maintenance Type Code and is included in all EDI transactions to identify the type of transaction that is being reported. Definitions and technical specifications for each MTC can be found in the IAIABC EDI Implementation Guide at <http://www.iaabc.org>.

^{*}If one or more benefit payments continue after the suspension of a concurrent benefit payment, use the MTC Px indicate a partial suspension. If all benefit payments are being suspended, use the MTC Sx.

For indemnity claims, the WCIS will support accept substitution of an FN (final) for a final AN (annual), provided that the claim is closed without further benefit activity.

^ΔIf the advance or settlement is the first indemnity payment, send the Initial Payment (IP) instead. Examples of an advance are a permanent disability advance or a temporary disability advance for a Qualified Medical Evaluation (QME) appointment. Advances should be reported using the appropriate Payment/Adjustment Codes (DN85). Examples of settlements are Compromise and Release (C&R), commutation and stipulated settlements. Settlements should be sent with the 5xx compromised Payment/Adjustment Codes (DN85). Please refer to Section M-System Specifications for more details.

November 15, 2011 (DATE TO BE INSERTED BY OAL - 6.12 MONTHS FOLLOWING APPROVAL AND FILING WITH 54 SECRETARY OF STATE)

Release 1**Annual Summary**

For claims with date of injury July 1, 2000 or later.

MTC [†]	Event	Time Report is Due
AN#	<p>Cumulative totals of payments in any benefit category (including medical) through the previous calendar year that had a payment in the same year.</p> <p>The exception to this rule is for the claims where there is no further benefit activity after the final (FN) report has been accepted and the FN included all the <u>medical</u>, indemnity and/or non-indemnity benefit data. If no payments were made in the previous calendar year, then an AN does not need to be filed for that year.</p>	By January 31 for the preceding year (starting in 2001)

WCIS will only support the AN (annual) and the FN (final) periodic reports. Any other periodic reports will be rejected.

[†]MTC is the Maintenance Type Code. The MTC is included in all EDI transactions to identify the type of transaction that is being reported. Definitions and technical specifications for each MTC can be found in the IAIABC EDI Implementation Guide at <http://www.iaiabc.org>.

#For non-indemnity claims, WCIS will accept substitution of a final AN (annual) for a FN (final), provided that the AN reports the claim status (DN73) as closed.

Section K: Required Data Elements

This section indicates the data elements that are to be included in EDI transmission of First Reports of Injury and Subsequent Reports of Injury. Specific requirements depend upon the type of transaction reported (original report, change, correction, etc.) The transaction type is identified by the Maintenance Type Code, or MTC. Definitions and technical specifications for each MTC and data element can be found in the IAIABC EDI Implementation Guide at <http://www.iaiaabc.org>.

To fully understand the reporting requirements for each data element, please see **both** the data requirement tables and the associated conditional rules and implementation notes. The Conditional Rules and Implementation Notes tables provide specific details on when conditional requirements for each data element apply, as well as California implementation notes.

WCIS Data Requirement Codes

The WCIS incorporates flexible data handling. Rather than requiring all data elements on all reports, WCIS specifies a minimal list of data items that must be provided in a given situation. Each data element is designated as Mandatory, Conditional, or Optional for each transaction type. Validity errors for required data elements are designated Fatal, Serious, or Minor.

The table below describes the designations of data requirements in the WCIS. The data requirements tables that follow specify which designation applies for each data element on a given transaction.

Code	Description
M/F Fatal	Reporting is Mandatory. Validity errors are Fatal and will result in rejection of the faulty record.
M/S Serious	Reporting is Mandatory. Validity errors are Serious: WCIS will accept the faulty record but will produce an error message.
M/M Minor	Reporting is Mandatory. Validity errors are regarded as Minor. No error message will be returned. Errors will be tracked internally and may be summarized periodically for each claims administrator.
C/F Fatal	Reporting is Conditional. Validity errors are Fatal when reporting conditions are present and will result in rejection of the faulty record.
C/S Serious	Reporting is Conditional. Validity errors are Serious when the reporting conditions are present. WCIS will accept the faulty record, but will produce an error message.
C/M Minor	Reporting is Conditional. Validity errors are regarded as Minor, often because WCIS cannot detect the conditions under which these elements should be reported. No error message will be produced.
O Optional	Reporting is Optional. No error messages will be produced.

Note: Error severity levels may evolve over time. Ample notification will be provided of any planned changes.

Data Requirements for First Reports of Injury

DN# Release 1 Data Element Name		Maintenance Type Codes				
		Original	Acquired / Unallocated	Cancel	Denial	Change, Correction
		00	AU	01	04*	02, CO
Transaction						
1	Transaction Set ID	M/F	M/F	M/F	M/F	M/F
2	Maintenance Type Code	M/F	M/F	M/F	M/F	M/F
3	Maintenance Type Code Date	M/F	M/F	M/F	M/F	M/F
Jurisdiction						
4	Jurisdiction	M/F	M/F	M/F	M/F	M/F
Insurer						
6	Insurer FEIN	M/F	M/F	M/F	M/F	M/F
7	Insurer Name	M/F	M/F	O	M/F	M/S
Claim Administrator						
8	Third Party Claim Administrator FEIN	<u>C/F</u> <u>M/E</u>	<u>C/F</u> <u>M/E</u>	<u>C/F</u> <u>M/F</u>	<u>C/F</u> <u>M/F</u>	<u>C/F</u> <u>M/F</u>
9	Third Party Claim Administrator Name	<u>C/S</u> <u>M/S</u>	<u>C/S</u> <u>M/S</u>	<u>C/S</u> <u>O</u>	<u>C/S</u> <u>M/S</u>	<u>C/S</u> <u>M/S</u>
10	Claim Administrator Address Line 1	M/M	M/M	O	M/M	M/M
11	Claim Administrator Address Line 2	C/M	C/M	O	C/M	C/M
12	Claim Administrator City	M/M	M/M	O	M/M	M/M
13	Claim Administrator State	M/M	M/M	O	M/M	M/M
14	Claim Administrator Postal Code**	M/F	M/F	O	M/F	M/F
Employer						
16	Employer FEIN	M/S	M/S	O	M/S	M/S
18	Employer Name	M/S	M/S	O	M/F	M/S
19	Employer Address Line 1	M/M	M/M	O	M/M	M/M
20	Employer Address Line 2	C/M	C/M	O	C/M	C/M

NOTES:

- * Denial 04: If a claim is denied and no benefit was paid, then FROI MTC 04 Denial must be sent.
- ** DN14 is the 9-digit Postal Code of the physical location of the Claims Administrator handling this claim.

Data Requirements for First Reports of Injury

DN#	Release 1 Data Element Name
-----	-----------------------------

Maintenance Type Codes				
Original	Acquired / Unallocated	Cancel	Denial	Change, Correction
00	AU	01	04*	02, CO

Employer, continued

21	Employer City	M/M	M/M	O	M/M	M/M
22	Employer State	M/M	M/M	O	M/M	M/M
23	Employer Postal Code	M/S	M/S	O	M/S	M/S
24	Self-Insured Indicator	M/F	M/S	O	M/F	M/S
25	Industry Code	M/S	M/S	M/S O	M/S	M/S

Accident

31	Date of Injury	M/F	C/F	O M/F O	M/F	M/F
32	Time of Injury	OC/S	OC/S	O	OC/S	OC/S
33	Postal Code of Injury Site	M/S	M/S	O	M/S	M/S
35	Nature of Injury Code	M/S	C/S M/S	O	M/S	M/S
36	Part of Body Injured Code	M/S	C/S M/S	O	M/S	M/S
37	Cause of Injury Code	M/S	M/S	O	M/S	M/S
38	Accident Description/Cause	M/M	M/M	O	M/M	M/M
39	Initial Treatment	OC/S O	OC/S OOC/S	O	OC/S OC/S	OC/S OC/S
40	Date Reported to Employer	M/S	M/S	O	M/M	M/S
41	Date Reported to Claim Administrator	M/S	M/S	O	M/S	M/S

Claim

5	Agency Claim Number***	***	C/M	C/FM/F	C/M	C/FM/F
15	Claim Administrator Claim Number	M/F	M/F	C/FM/F	M/F	M/F
26	Insured Report Number	O	O	O	O	O
28	Policy Number	C/S	C/S O	O	C/S O	C/S
29	Policy Effective Date	C/S	C/S O	O	C/S O	C/S
30	Policy Expiration Date	C/S	C/S O	O	C/S O	C/S

Employee

42	Social Security Number	M/S	M/S	O	M/S	M/S
43	Employee Last Name	M/F	C/F	O	M/F	M/F
44	Employee First Name	M/F	C/F	O	M/F	M/F
45	Employee Middle Initial	C/M	C/M	O	C/M	C/M
46	Employee Address Line 1	M/M	M/M	O	M/M	M/M
47	Employee Address Line 2	C/M	C/M	O	C/M	C/M

~~November 15, 2011~~ (DATE TO BE INSERTED BY OAL - ~~6~~ 12 MONTHS FOLLOWING APPROVAL AND FILING WITH SECRETARY OF STATE)

Data Requirements for First Reports of Injury

DN#	Release 1 Data Element Name
-----	-----------------------------

Maintenance Type Codes				
Original	Acquired / Unallocated	Cancel	Denial	Change, Correction
00	AU	01	04*	02, CO

Employee, continued

48	Employee City	M/M	M/M	O	M/M	M/M
49	Employee State	M/M	M/M	O	M/M	M/M
50	Employee Postal Code	M/M	M/M	O	M/M	M/M
51	Employee Phone	C/M	C/M	O	C/M	C/M
52	Employee Date of Birth	M/S <u>M/F</u>	M/S <u>C/F</u>	O <u>M/F</u> <u>OM/F</u>	M/S M/F	M/S <u>M/F</u>
53	Gender Code	M/S	M/S	O	M/S	M/S
54	Marital Status Code	C/S	C/S	O	C/S	C/S
55	Number of Dependents	C/S	C/S	O	C/S	C/S
56	Date Disability Began****	C/M	C/M	O	C/M	C/M
57	Employee Date of Death	C/M	C/M	O	C/M	C/M
68	Date of Return to Work	C/M	C/M	O	C/M	C/M

Employment

58	Employment Status Code	M/M	M/M	O	M/M	M/M
59	Class Code*****	M/S <u>C/S</u>	M/S <u>C/S</u>	O	M/S <u>O</u>	M/S <u>C/S</u>
60	Occupation Description	M/S	M/S	O	M/S	M/S
61	Date of Hire	M/M	M/M	O	M/M	M/M
62	Wage	C/M <u>M/S</u> <u>C/M</u>	C/M <u>M/S</u> <u>C/M</u>	O	C/M <u>M/S</u> <u>C/M</u>	C/M <u>M/S</u> <u>C/M</u>
63	Wage Period	G/S <u>M/S</u> <u>C/S</u>	C/S <u>M/S</u> <u>C/S</u>	O	C/S <u>M/S</u> <u>C/S</u>	G/S <u>M/S</u> <u>C/S</u>
65	Date Last Day Worked	C/M	C/M	O	C/M	C/M
67	Salary Continued Indicator	M/M	M/M	O	M/M	M/M

NOTES:

- * Denial 04: If a claim is denied and no benefit was paid, then FROI MTC 04 Denial must be sent.
- ** DN14 is the 9 digit Postal Code of the physical location of the Claims Administrator handling this claim.
- *** DN5 (Agency Claim Number/Jurisdiction Claim Number) must be blank on the 00 FROI.
- **** The FROI Date Disability Began is defined by DWC as the original date of lost time.
- ***** DN59 (Class Code) is the California-specific class code from the Workers' Compensation Insurance Rating Bureau (WCIRB) of California. The National Council on Compensation Insurance (NCCI) class codes are not accepted.

FROI Conditional Rules and Implementation Notes

DN#	Release 1 Data Element Name	Notes or explanation of Conditional Requirements (C/F or C/S)
Transaction		
1	Transaction Set ID	
2	Maintenance Type Code	
3	Maintenance Type Code Date	
Jurisdiction		
4	Jurisdiction Code	CALIFORNIA EDIT: Must be "CA".
Insurer		
6	Insurer FEIN	If self-insured, provide Employer FEIN in this field.
7	Insurer Name	If self-insured, provide Employer Name in this field.
Claim Administrator		
8	Third Party Claim Administrator FEIN	If not self-administered, then Mandatory provide Insurer FEIN as Claim Administrator FEIN
9	Third Party Claim Administrator Name	If TPA FEIN provided, then TPA Name Mandatory. If self-administered, then provide Insurer Name as Claim Administrator Name
10	Claim Administrator Address Line 1	
11	Claim Administrator Address Line 2	
12	Claim Administrator City	
13	Claim Administrator State	
14	Claim Administrator Postal Code	Must be a valid Postal code.
Employer		
16	Employer FEIN	If employer has no FEIN or refuses to provide, send "000000006 ". Employer FEIN should cannot equal Insurer FEIN unless self-insured.
18	Employer Name	
19	Employer Address Line 1	
20	Employer Address Line 2	
21	Employer City	
22	Employer State	
23	Employer Postal Code	Must be a valid Postal code.
24	Self-Insured Indicator	
25	Industry Code	See Section N for reporting guidelines on industry code.
Accident		
31	Date of Injury	If MTC=AU AND Jurisdiction Claim Number (DN5) not provided, then Mandatory.
32	Time of Injury	For MTCs 00, 04, CO, and 02, if Date of Injury (DN31) >= Date of FROI/SROI Guide version 3.1 Implementation, and if Nature of Injury Code (DN 35) is not between 60 and 80, then Time of Injury (DN 32), then Mandatory. Not required on 04, CO, or 02 for previously acquired claims.
33	Postal Code of Injury Site	Must be a valid Postal code.
35	Nature of Injury Code	If MTC=AU AND Jurisdiction Claim Number (DN5) not provided, then Mandatory.

36	Part of Body Injured Code	If MTC=AU AND Jurisdiction Claim Number (DN5) not provided, then Mandatory.
37	Cause of Injury Code	
38	Accident Description/Cause	
39	Initial Treatment	If Date of Injury (DN31) >= Date of FROI/SROI Guide version 3.1 Implementation, then mandatory.
40	Date Reported to Employer	
41	Date Reported to Claim Administrator	Must be a valid date.

DRAFT

FROI Conditional Rules and Implementation Notes

DN#	Release 1 Data Element Name	Notes or explanation of Conditional Requirements (C/F or C/S)
Claim		
5	Jurisdiction Claim Number/ Agency Claim Number	For MTC =AU or 04, send if available. For FROI MTC=01, 02, CO and all Subsequent Reports: Self-administered Insurers: If Insurer FEIN (DN6) AND Claim Administrator Claim Number (DN15) are missing, then Agency Claim Number/Jurisdiction Claim Number (DN5) is Mandatory. Third Party-administered Insurers: If TPA FEIN (DN8) AND Insurer FEIN (DN6) AND Claim Administrator Claim Number (DN15) are missing, then Agency Claim Number/Jurisdiction Claim Number (DN5) is Mandatory.
15	Claim Administrator Claim Number	For FROI MTC=01 and all Subsequent Reports (except 02 & CO): If JCN (DN5) is missing, then Claim Administrator Claim Number (DN15) is Mandatory.
26	Insured Report Number	
28	Policy Number	If (MTC=00, AU, 04, 02, or CO) AND Self Insured Indicator (DN24)=N, then Mandatory.
29	Policy Effective Date	If (MTC=00, AU, 04, 02, or CO) AND Self Insured Indicator (DN24)=N, then Mandatory.
30	Policy Expiration Date	If (MTC=00, AU, 04, 02, or CO) AND Self Insured Indicator (DN24)=N, then Mandatory.
Employee		
42	Social Security Number	If employee has no SSN or refuses to provide, send "000000006".
43	Employee Last Name	If MTC=AU AND Jurisdiction Claim Number (DN5) not provided, then Mandatory.
44	Employee First Name	If MTC=AU AND Jurisdiction Claim Number (DN5) not provided, then Mandatory.
45	Employee Middle Initial	
46	Employee Address Line 1	
47	Employee Address Line 2	
48	Employee City	
49	Employee State	
50	Employee Postal Code	Must be a valid postal code.
51	Employee Phone	
52	Employee Date of Birth	If MTC=AU, AND Jurisdiction Claim Number (DN5) not provided, then Mandatory.
53	Gender Code	
54	Marital Status Code	If Date of Death provided, then Mandatory.
55	Number of Dependents	If Date of Death provided, then Mandatory.
56	Date Disability Began	FROI Date Disability Began is the original date of lost time.
57	Employee Date of Death	Mandatory if injured worker died.
68	Date of Return to Work	

FROI Conditional Rules and Implementation Notes

DN#	Release 1 Data Element Name	Notes or explanation of Conditional Requirements (C/F or C/S)
Employment		
58	Employment Status Code	For self-insureds (DN24=Y), send a valid WCIRB class code or send no code at all. For all others, a valid WCIRB class code must be sent. If Average Wage (DN62) provided, then Mandatory. <u>If Average Wage (DN62) provided, then Mandatory.</u>
59	Class Code	
60	Occupation Description	
61	Date of Hire	
62	Wage	
63	Wage Period	
65	Date Last Day Worked	
67	Salary Continued Indicator	

DRAFT

Data Requirements for Subsequent Reports of Injury

		Maintenance Type Code															
Initial Payment	Acquired Payment	Full Salary	Compensable Death	Partial Denial	Denial	Change in Amount	Change in Benefit	Reduced Earnings	Partial Suspensions	Suspensions	Reinstatement of Benefits	Change, Correction	Payment	Final	Annual	Upon Request	
IP	AP	FS	CD	4P	04*	CA	CB	RE	P1-9, PJ	S1-9, SJ	RB	02, CO	PY	FN	AN	UR	
DN #	Release 1 Data Element Name																
Transaction																	
1	Transaction Set ID	M/F	M/F	M/F	M/F	M/F	M/F	M/F	M/F	M/F	M/F	M/F	M/F	M/F	M/F	M/F	M/F
2	Maintenance Type Code	M/F	M/F	M/F	M/F	M/F	M/F	M/F	M/F	M/F	M/F	M/F	M/F	M/F	M/F	M/F	M/F
3	Maintenance Type Code Date	M/F	M/F	M/F	M/F	M/F	M/F	M/F	M/F	M/F	M/F	M/F	M/F	M/F	M/F	M/F	M/F
Jurisdiction																	
4	Jurisdiction	M/F	M/F	M/F	M/F	M/F	M/F	M/F	M/F	M/F	M/F	M/F	M/F	M/F	M/F	M/F	M/F
Insurer																	
6	Insurer FEIN	M/F	M/F	M/F	M/F	M/F	M/F	M/F	M/F	M/F	M/F	M/F	M/F	M/F	M/F	M/F	M/F
Claim Administrator																	
8	Third-Party Claim Administrator FEIN	C/F	C/F	C/F	C/F	C/F	C/F	C/F	C/F	C/F	C/F	C/F	C/F	C/F	C/F	C/F	C/F
14	Claim Administrator Postal Code**	M/F	M/F	M/F	M/F	M/F	M/F	M/F	M/F	M/F	M/F	M/F	M/F	M/F	M/F	M/F	M/F
Accident																	
31	Date of Injury	O M/F	O M/F	O M/F	O M/F	O M/F	O M/F	O M/F	O M/F	O M/F	O M/F	O M/F	M/F	O M/F	O M/F	O M/F	O M/F
Claim																	
5	Agency Claim Number	C/F M/F	C/F M/F	C/F M/F	C/F M/F	C/F M/F	C/F M/F	C/F M/F	C/F M/F	C/F M/F	C/F M/F	C/F M/F	C/F M/F	C/F M/F	C/F M/F	C/F M/F	C/F M/F
15	Claim Administrator Claim Number	C/F M/F	C/F M/F	C/F M/F	C/F M/F	C/F M/F	C/F M/F	C/F M/F	C/F M/F	C/F M/F	C/F M/F	C/F M/F	M/F	C/F M/F	C/F M/F	C/F M/F	C/F M/F
26	Insured Report Number	O	O	O	O	O	O	O	O	O	O	O	O	O	O	O	O
73	Claim Status	O	O	O	O	M/S	M/S	O	O	O	O	O	M/S	M/S	M/S M/F	O M/F	M/S
74	Claim Type	O M/F	O M/F	O M/F	O	O M/F	O M/F	O M/F	O M/F	O M/F	O M/F	O M/F	O	O M/F	O M/F	O M/F	O M/F
76	Date of Representation	C/M	C/M	C/M	C/M	C/M	C/M	C/M	C/M	C/M	C/M	C/M	C/M	C/M	C/M	C/M	C/M

Data Requirements for Subsequent Reports of Injury

		Maintenance Type Code																	
DN #	Release 1 Data Element Name	Initial Payment	Acquired Payment	Full Salary	Compensable Death	Partial Denial	Denial	Change in Amount	Change in Benefit	Reduced Earnings	Partial Suspensions	Suspensions	Reinstatement of Benefits	Change, Correction	Payment	Final	Annual	Upon Request	
		IP	AP	FS	CD	4P	04*	CA	CB	RE	P1-9, PJ	S1-9, SJ	RB	02, CO	PY	FN	AN	UR	
Employee																			
42	Social Security Number	O	O	O	O	O	O	O	O	O	O	O	O	C/M	O	O	O	O	
55	Number of Dependents	O	O	O	C/S	O	O	O	O	O	O	O	O	C/S	O	O	O	O	
56	Date Disability Began***	C/S	C/M	C/S	O	O	O	O	C/S	O	O	O	C/S	C/S	O	O	O	C/S	
57	Employee Date of Death	OC/S	OC/S	OC/S	M/S	OC/S	OC/S	OC/S	OC/S	OC/S	C/S	C/S	OC/S	C/M	OC/S	C/S	OC/S	OC/S	
70	Date of Maximum Medical Improvement	O	O	O	O	O	O	O	O	O	O	O	O	O	O	C/F	O	C/F	
71	Return to Work Qualifier	C/M	C/M	C/M	O	O	O	C/M	C/M	M/S	C/S	C/S	O	C/M	O	O	O	C/M	
72	Date of Return/Release to Work	C/M	C/M	C/M	O	O	O	C/M	C/M	M/S	C/S	C/S	O	C/M	O	O	O	C/M	
Employment																			
62	Wage	M/S	M/S	O	O	O	O	M/S	M/S	O	O	O	O	M/S	O	O	O	M/S	
63	Wage Period	C/S	C/S	O	O	O	O	C/S	C/S	O	O	O	O	C/S M/S	O	O	O	C/S	
67	Salary Continued Indicator	M/S	M/S					M/S	M/S									M/S	
67	Salary Continued Indicator	O	O	M/M	O	O	O	O	O	O	O	O	O	M/M	O	O	O	O	
Payments																			
77	Late Reason Code	C/M	C/M	C/M	O	O	C/M	C/M	C/M	C/M	C/M	C/M	C/M	C/M	C/M	C/M	O	C/M	

NOTES:

~~* The SROI Date Disability Began (DN56) is defined by DWC as the first date of lost time for the current benefit period.~~

Data Requirements for Subsequent Reports of Injury

DN #		Release 1 Data Element Name		Maintenance Type Code															
				Initial Payment	Acquired Payment	Full Salary	Compensable Death	Partial Denial	Denial	Change in Amount	Change in Benefit	Reduced Earnings	Partial Suspensions	Suspensions	Reinstatement of Benefits	Change, Correction	Payment	Final	Annual
		IP	AP	FS	CD	4P	04*	CA	CB	RE	P1-9, PJ	S1-9, SJ	RB	02, CO	PY	FN	AN	UR	
Variable Segment																			
78		Number of Permanent Impairments		M/F	M/F	M/F	M/F	M/F	M/F	M/F	M/F	M/F	M/F	M/F	M/F	M/F	M/F	M/F	M/F
79		Number of Payments/Adjustments		M/F	M/F	M/F	M/F	M/F	M/F	M/F	M/F	M/F	M/F	M/F	M/F	M/F	M/F	M/F	M/F
80		Number of Benefit Adjustments		M/F	M/F	M/F	M/F	M/F	M/F	M/F	M/F	M/F	M/F	M/F	M/F	M/F	M/F	M/F	M/F
81		Number of Paid to Dates/Reduced Earnings/Recoveries		M/F	M/F	M/F	M/F	M/F	M/F	M/F	M/F	M/F	M/F	M/F	M/F	M/F	M/F	M/F	M/F
82		Number of Death Dependent/Payee Relationships		M/F	M/F	M/F	M/F	M/F	M/F	M/F	M/F	M/F	M/F	M/F	M/F	M/F	M/F	M/F	M/F
Permanent Impairments																			
83		Permanent Impairment Body Part Code		G/SQ	G/SQ	O	O	O	G/SQ	O	O	O	O	O	G/SQ	G/SQ	G/SC/E	O	G/SC/E
84		Permanent Impairment Percentage		O	O	O	O	O	O	O	O	O	O	O	O	O	C/F	O	C/F

Data Requirements for Subsequent Reports of Injury

DN #	Release 1 Data Element Name
------	-----------------------------

Maintenance Type Code																
Initial Payment	Acquired Payment	Full Salary	Compensable Death	Partial Denial	Denial	Change in Amount	Change in Benefit	Reduced Earnings	Partial Suspensions	Suspensions	Reinstatement of Benefits	Change, Correction	Payment	Final	Annual	Upon Request
IP	AP	FS	CD	4P	04*	CA	CB	RE	P1-9, PJ	S1-9, SJ	RB	02, CO	PY	FN	AN	UR

Benefit Payments

85	Payment/Adjustment Code	M/F	M/F	M/F	C/F	C/F	C/F	M/F	M/F	M/F	M/F	M/F	M/F	C/F	M/SF	C/SF	C/SF	C/F
86	Payment/Adjustment Paid to Date	M/F	M/F	M/F	C/F	C/F	C/F	M/F	M/F	M/F	M/F	M/F	M/F	C/F	M/SF	C/SF	C/SF	C/F
87	Payment/Adjustment Weekly Amount	M/F	M/F	M/F	O	C/F	O	M/F	M/F	M/F	M/F	M/F	M/F	C/F	O	C/F	C/F	C/F
88	Payment/Adjustment Start Date	M/F	M/F	M/F	C/F	C/F	C/F	M/F	M/F	M/F	M/F	M/F	M/F	C/F	C/F	C/F	C/F	C/F
89	Payment/Adjustment End Date	M/F	M/F	M/F	C/F	C/F	C/F	M/F	M/F	M/F	M/F	M/F	M/F	C/F	C/F	C/F	C/F	C/F
90	Payment/Adjustment Weeks Paid	M/F	M/F	M/F	O	C/F	O	M/F	M/F	M/F	M/F	M/F	M/F	C/F	O	C/F	C/F	C/F
91	Payment/Adjustment Days Paid	M/F	M/F	M/F	O	C/F	O	M/F	M/F	M/F	M/F	M/F	M/F	C/F	O	C/F	C/F	C/F

Benefit Adjustments

92	Benefit Adjustment Code	O	O	O	O	O	O	O	O	O	O	O	O	O	O	O	O	O
93	Benefit Adjustment Weekly Amount	O	O	O	O	O	O	O	O	O	O	O	O	O	O	O	O	O
94	Benefit Adjustment Start Date	O	O	O	O	O	O	O	O	O	O	O	O	O	O	O	O	O

Paid to Date

95	Paid to Date/Reduced Earnings/Recoveries Code	C/M	C/M	C/M	C/M	C/M	C/M	C/M	C/M	C/M	C/M	C/M	C/M	C/M	O	C/S	C/S	C/M
96	Paid to Date/Reduced Earnings/Recoveries Amount	C/M	C/M	C/M	C/M	C/M	C/M	C/M	C/M	C/M	C/M	C/M	C/M	C/M	O	C/S	C/S	C/M

NOTES:

* SROI 04 Denial: If a claim is denied and benefits were paid, then SROI MTC 04 Denial must be sent.

** DN14 is the 9 digit Postal Code of the physical location of the Claims Administrator handling this claim.

*** The SROI Date Disability Began (DN56) is defined by DWC as the first date of lost time for the current benefit period.

SROI Conditional Rules and Implementation Notes

DN#	Release 1 Data Element Name	Notes or explanation of Conditional Requirements (C/F or C/S)
Transaction		
1	Transaction Set ID	If MTC = CB or RB, then must be preceded by at least one previous benefit event of any Payment/Adjustment Code. If MTC = FS, then must contain benefit record with Payment/Adjustment Code = 240 or 524. If MTC = FN, then all previously reported benefit periods should be closed. If MTC = VE, BM, BW, MN, QT, or SA reported transaction will be rejected.
2	Maintenance Type Code	
3	Maintenance Type Code Date	
Jurisdiction		
4	Jurisdiction	CALIFORNIA EDIT: Must be "CA".
Insurer		
6	Insurer FEIN	If self-insured, provide Employer FEIN in this field.
Claim Administrator		
8	Third Party Claim Administrator FEIN	If not self-administered, then <u>Mandatory</u> provide Insurer FEIN as Claim Administrator FEIN. Must be a valid postal code.
14	Claim Administrator Postal Code	
Accident		
31	Date of Injury	
Claim		
5	Jurisdiction Claim Number/Agency Claim Number	For FROI MTC=01, 02, CO and all Subsequent Reports Self-administered Insurers: If Insurer FEIN (DN6) AND Claim Administrator Claim Number (DN15) are missing, then Agency Claim Number/Jurisdiction Claim Number (DN5) is Mandatory. Third Party-administered Insurers: If TPA FEIN (DN8) AND Insurer FEIN (DN6) AND Claim Administrator Claim Number (DN15) are missing, then Agency Claim Number/Jurisdiction Claim Number (DN5) is Mandatory.
15	Claim Administrator Claim Number	For FROI MTC=01 and all Subsequent Reports (except 02 & CO): If JCN (DN5) is missing, then Claim Administrator Claim Number (DN15) is Mandatory.
26	Insured Report Number	
73	Claim Status	FATAL EDIT: If MTC = FN, then Claim Status must = C or X.
74	Claim Type	
76	Date of Representation	

SROI Conditional Rules and Implementation Notes

DN#	Release 1 Data Element Name	Notes or explanation of Conditional Requirements (C/F or C/S)
Employee		
42	Social Security Number	If employee has no SSN or refuses to provide, send "000000006"
55	Number of Dependents	If Date of Death provided, then Mandatory.
56	Date Disability Began	<u>SROI Date Disability Began is the first date of lost time for the current benefit period.</u> If reporting temporary disability benefits (DN85=050, 051, or 070), then Mandatory. <u>If Nature of Injury Code (DN 35) is not between 60 and 80, then DOI (DN 31) <= DDB (DN 56) is Mandatory.</u>
57	Employee Date of Death	If MTC=P4 or MTC=S4 or [MTC=FN and transaction includes any Payment/Adjustment Code (DN85) = 010 or 510], then Mandatory. <u>If Paid to Date/Reduced Earnings/Recoveries code (DN95) = 300 then Mandatory.</u>
70	Date of Maximum Medical Improvement	If reporting and closing permanent disability benefits (DN85=020, 021, 030, 040, <u>or 090 or 520, 521, 530, 540, or 590</u>), <u>DN31 < 1/1/2013, and MMI date is known, then Mandatory.</u> <u>If reporting and closing and closing permanent disability benefits (DN85=020, 021, 030, 040, or 090) and DN31 > = 1/1/2013, then Mandatory.</u>
71	Return to Work Qualifier	If MTC=S1 or MTC=P1 (returned to work), then Mandatory.
72	Date of Return/Release to Work	If MTC=S1 or MTC=P1 (returned to work), then Mandatory. Must be a valid date.
Employment		
62	Wage	
63	Wage Period	If Wage (DN62) provided, then Mandatory.
67	Salary Continued Indicator	
Payments		
77	Late Reason Code	
Variable Segment		
78	Number of Permanent Impairments	EDIT: Must be >0 if [MTC={IP, AP, AB, CB, PY, FN, SROI 02 or SROI CO} AND starting or updating PD benefits (i.e. DN86>0 AND DN85={020, 021, 030, 040 or 090}) AND DN70 is present]; SERIOUS error, <u>error code = 62; required segment not present.</u>
79	Number of Payment Adjustments	FATAL EDIT: If [MTC={IP, AP, FS, CA, CB, RE, Px, Sx, or RB}] then DN79 must be >0; SERIOUS EDIT: If [MTC=4P or (MTC=PY and DN81 = 0) or (MTC={AN or FN} and Claim Administrator previously reported events with DN86>0) then DN79 must be > 0; error code = 62; Required segment not present.
80	Number of Benefit Adjustments	
81	Number of Paid to Dates/Reduced Earnings/Recoveries	EDIT: If [(MTC=PY and DN79 = 0) or (MTC=AN and Claim Administrator previously reported events with DN96>0)] then must have DN81>0. FATAL Error, code = 062: Required segment not present.
82	Number of Death Dependent/Payee Relationships	

SROI Conditional Rules and Implementation Notes

DN#	Release 1 Data Element Name	Notes or explanation of Conditional Requirements (C/F or C/S)
Permanent Impairments		
83	Permanent Impairment Body Part Code	Use Codes 90 (Multiple Body Parts) or 99 (Whole Body) to reflect combined rating for all impairments. If [MTC={IP, AP, SROI 04, CB, PY, FN, SROI 02, SROI CO or SROI UR} AND starting, denying or updating PD benefits (i.e. DN86>0 AND DN85= DN85 =020, 021, 030, 040, 090 or 520, 521, 530, 540, or 590))] then Mandatory.
84	Permanent Impairment Percentage	Report percent for DN83=90 (Multiple Body Parts) or 99 (Whole Body) to reflect combined rating for any/all impairments. If [MTC={IP, AP, SROI 04, CB, PY, FN, SROI 02, SROI CO or SROI UR} AND reporting PD benefits (i.e. DN86>0 AND DN85= DN85 =020, 021, 030, 040, 090 or 520, 521, 530, 540, or 590))] then Mandatory.
Benefit Payments		
85	Payment/Adjustment Code	If [MTC={AN, FN, CD, 4P, UR or SROI 04} AND database includes any open or closed benefit records with DN86>0], then Mandatory. If [(MTC = 02 or MTC = CO) AND indemnity payment previously reported], then Mandatory. FATAL EDIT: If DN86 is reported, DN85 must be a valid Payment/Adjustment code. <u>If (MTC=AN or FN and DN79 > 0), then Mandatory.</u>
86	Payment/Adjustment Paid to Date	If [MTC={AN, FN, CD, 4P, UR or SROI 04} AND database includes any open or closed benefit records with DN86>0], then Mandatory. If [(MTC = 02 or MTC = CO) AND indemnity payment previously reported], then Mandatory. FATAL EDIT: If DN85 is reported, DN86 must be >= 0.

SROI Conditional Rules and Implementation Notes

DN#	Release 1 Data Element Name	Notes or explanation of Conditional Requirements (C/F or C/S)
Benefit Payments		
87	Payment/Adjustment Weekly Amount	<p>If [MTC={AN, FN, UR, 4P, SROI 02 or CO} AND DN85 = 010, 020, 030, 040, 050, 051, 070, 080, 090, 240, 410}, then Mandatory</p> <p>Note: If using DN85/DN86 to report a lump-sum payment or settlement, MTC, Start and End Date is assumed to be the settlement date. <u>If reporting a stipulated settlement, the payment/adjustment start and end date for the initial stipulated payment should cover the initial payment period. The last payment should cover the last payment period of the settlement.</u></p>
88	Payment/Adjustment Start Date	<p>If using DN85/DN86 to report a lump-sum payment or settlement, MTC, Start and End Date is the settlement date. If {(MTC=SROI 02, 04, 4P, CD, CO, PY, AN, FN, or UR) and (DN86 > 0) and DN31 >=6/18/2012} then Mandatory.</p> <p><u>If Nature of Injury Code (DN 35) is not between 60 and 80, then DOI (DN 31) <= <-Start Date (DN 88) is Mandatory.</u></p>
89	Payment/Adjustment End Date	<p>EDIT: Must be >= Ben. Period Start Date (DN88).</p> <p>Note: If using DN85/DN86 to report a lump-sum payment or settlement, MTC, Start and End Date is assumed to be the settlement date. <u>If reporting a stipulated settlement, the payment/adjustment start and end date for the initial stipulated payment should cover the initial payment period. The last payment should cover the last payment period of the settlement.</u></p> <p>If {(MTC=SROI 02, 04, 4P, CD, CO, PY, AN, FN, or UR) and (DN86 > 0) and DN31 >=6/18/2012} then Mandatory.</p> <p><u>If Nature of Injury Code (DN 35) is not between 60 and 80, then DOI (DN 31) <= <-End Date (DN 89) is Mandatory.</u></p>
90	Payment/Adjustment Weeks Paid	If [MTC={4P, AN, FN, UR, 4P, SROI 02 or CO} AND DN85 = 010, 020, 030, 040, 050, 051, 070, 080, 090, 240, 410}, then Mandatory
91	Payment/Adjustment Days Paid	If [MTC={4P, AN, FN, UR, 4P, SROI 02 or CO} AND DN85 = 010, 020, 030, 040, 050, 051, 070, 080, 090, 240, 410}, then Mandatory
Benefit Adjustments		
92	Benefit Adjustment Code	FATAL EDIT: If DN93 is reported, DN92 must be a valid Benefit Adjustment code.
93	Benefit Adjustment Weekly Amount	FATAL EDIT: If DN92 is reported, DN93 must be >= 0.
94	Benefit Adjustment Start Date	
Paid to Dates		
95	Paid to Date/Reduced Earnings/Recoveries Code	<p>If MTC=AN or MTC = FN AND Claim Administrator previously reported events with DN96>0, then Mandatory.</p> <p>FATAL EDIT: If DN96 is reported, DN95 must be a valid Paid To Date code.</p>

96 Paid to Date/Reduced Earnings/Recoveries Amount

If MTC=AN or MTC = FN AND Claim Administrator previously reported events with DN96>0, then Mandatory.
FATAL EDIT: If DN95 is reported, DN96 must be >= 0.

DRAFT

Section L: California-Specific-Data Edits and Sorted Adopted IAIABC Data Element Lists

The California-adopted edits from the IAIABC’s Release 1.0 EDI FROI SROI Implementation Guide are described below. See the *IAIABC EDI Implementation Guide*, available at <http://www.iaabc.org> for information on standard IAIABC edits. California-specific data edits supplement the standard IAIABC edits, which are a part of the WCIS system. See the *IAIABC EDI Implementation Guide*, available at <http://www.iaabc.org> for information on standard IAIABC edits.

Current California-Specific Data Edits

At this time, data sent to the WCIS are subject to California-specific edits, such as Jurisdiction Code (DN4) must be “CA”. Additional edits are listed in the tables below.

All Transactions

DN	Data Element Name	CA-Specific Data Edit(s)
2	MAINTENANCE TYPE CODE	See “Transaction Sequence Requirement” tables in <i>Section M – System Specifications</i>
3	MAINTENANCE TYPE CODE DATE	Must be >= DATE OF INJURY (DN31) Must be <= CURRENT DATE
4	JURISDICTION CODE	Must = “CA”
6	INSURER FEIN	Must match insurer FEIN on INSURER/CLAIM ADMINISTRATOR ID list for Sender
8	THIRD PARTY CLAIM ADMINISTRATOR FEIN	Must match TPA Claim Administrator FEIN on INSURER/CLAIM ADMINISTRATOR ID list for Sender
15	CLAIM ADMINISTRATOR CLAIM NUMBER	Must not contain special characters: “*”, “~”

First Reports (FROIs)

DN	Data Element Name	CA-Specific Data Edit(s)
5	AGENCY CLAIM NUMBER/JURISDICTION CLAIM NUMBER	Must be NULL for MTC 00
10	CLAIM ADMINISTRATOR ADDRESS LINE 1	Must not consist solely any of the following non-case sensitive strings: “unk”, “unknown”, “dk”, “don’t know”, “na”, “n/a”
12	CLAIM ADMINISTRATOR CITY	Must not consist solely of any of the following non-case sensitive strings: “unk”, “unknown”, “dk”, “don’t know”, “na”, “n/a”
18	EMPLOYER NAME	Must not consist solely of any of the following non-case sensitive strings: “unk”, “unknown”, “dk”, “don’t know”, “na”, “n/a”

First Reports (cont.)

DN	DATA ELEMENT NAME	CA-Specific Data Edit(s)
19	EMPLOYER ADDRESS LINE 1	Must not consist solely of any of the following non-case sensitive strings: "unk", "unknown", "dk", "don't know", "na", "n/a"
21	EMPLOYER CITY	Must not consist solely of any of the following non-case sensitive strings: "unk", "unknown", "dk", "don't know", "na", "n/a"
25	INDUSTRY CODE	Must be a valid NAICS industry code
31	DATE OF INJURY	Must be >= Date of Hire (DN61) (Disregard IAIABC edit: Must be <= Date of Hire)
42	SOCIAL SECURITY NUMBER	Must be 9 digits Must not equal "123456789" Must not be the same digits, e.g. 111111111, 222222222, etc. Must not equal "987654321"
43	EMPLOYEE LAST NAME	Must not consist solely of any of the following non-case sensitive strings: "unk", "unknown", "dk", "don't know", "na", "n/a"
44	EMPLOYEE FIRST NAME	Must not consist solely of any of the following non-case sensitive strings: "unk", "unknown", "dk", "don't know", "na", "n/a"
46	EMPLOYEE ADDRESS LINE 1	Must not consist solely of any of the following non-case sensitive strings: "unk", "unknown", "dk", "don't know", "na", "n/a"
48	EMPLOYEE CITY	Must not consist solely of any of the following non-case sensitive strings: "unk", "unknown", "dk", "don't know", "na", "n/a"
51	EMPLOYEE PHONE	All digits cannot be the same
56	DATE DISABILITY BEGAN	Must be >= DATE LAST DAY WORKED (DN65)
59	CLASS CODE	For self-insureds: if a class code is sent, it must be a valid WCIRB class code. For all others: must be a valid WCIRB class code.
65	DATE LAST DAY WORKED	Must be <= DATE DISABILITY BEGAN (DN56)
68	DATE OF RETURN TO WORK	Must be >= DATE DISABILITY BEGAN (DN56)

Subsequent Reports (SROIs)

DN	Data Element Name	CA-Specific Data Edit(s)
70	DATE OF MAXIMUM MEDICAL IMPROVEMENT	Must be >= DATE DISABILITY BEGAN (DN56)
72	DATE OF RETURN/RELEASE TO WORK	Must be >= DATE OF RETURN TO WORK (DN68)
73	CLAIM STATUS	Must be = C or X on FN
85	PAYMENT/ADJUSTMENT CODE	Benefit Codes 021, 040, 051, 080, 410, 521, 541, 540, 551 and 580 should not be sent on most recent claims. *
86	PAYMENT/ADJUSTMENT PAID TO DATE	Must be >= \$0; Cannot be NULL
88	PAYMENT/ADJUSTMENT START DATE	Must be a valid date format
89	PAYMENT/ADJUSTMENT END DATE	Must be a valid date format
93	BENEFIT ADJUSTMENT WEEKLY AMOUNT	Must be >= \$0; Cannot be NULL
94	BENEFIT/ADJUSTMENT START DATE	Must be a valid date format
96	PAID TO DATE/REDUCED EARNINGS/RECOVERIES CODE	Must be >= \$0; Cannot be NULL

*See Section N-Code Lists for more information

~~California-adopted IAIABC Data Elements~~

California-adopted IAIABC Data Elements

FROI Data Elements, Sorted by Data Element Number (DN)

Release 1 - FROI - 148			CATEGORY: FROI Data
CA	DN	DATA ELEMENT NAME	Requirements Table
CA	0001	Transaction Set ID	Transaction
CA	0002	Maintenance Type Code	Transaction
CA	0003	Maintenance Type Code Date	Transaction
CA	0004	Jurisdiction Code	Jurisdiction
CA	0005	Agency Claim Number/Jurisdiction Claim Number	Claim
CA	0006	Insurer FEIN	Insurer
CA	0007	Insurer Name	Insurer
CA	0008	Third Party Claim Administrator FEIN	Claim Administrator
CA	0009	Third Party Claim Administrator Name	Claim Administrator
CA	0010	Claim Administrator Address Line 1	Claim Administrator
CA	0011	Claim Administrator Address Line 2	Claim Administrator
CA	0012	Claim Administrator City	Claim Administrator
CA	0013	Claim Administrator State Code	Claim Administrator
CA	0014	Claim Administrator Postal Code	Claim Administrator
CA	0015	Claim Administrator Claim Number	Claim
CA	0016	Employer FEIN	Employer
	0017	Insured Name	
CA	0018	Employer Name	Employer
CA	0019	Employer Address Line 1	Employer
CA	0020	Employer Address Line 2	Employer
CA	0021	Employer City	Employer
CA	0022	Employer State Code	Employer
CA	0023	Employer Postal Code	Employer
CA	0024	Self-Insured Indicator	Employer
CA	0025	Industry Code	Employer
CA	0026	Insured Report Number	Claim
	0027	Insured Location Number	
CA	0028	Policy Number	Claim
CA	0029	Policy Effective Date	Claim
CA	0030	Policy Expiration Date	Claim
CA	0031	Date of Injury	Accident
CA	0032	Time of Injury	Accident
CA	0033	Postal Code of Injury Site	Accident

~~November 15, 2011~~ (DATE TO BE INSERTED BY OAL - ~~6~~ 12 MONTHS FOLLOWING APPROVAL AND FILING WITH SECRETARY OF STATE)

	0034	Employer's Premises Indicator	
CA	0035	Nature of Injury Code	Accident

FROI Data Elements, Sorted by Data Element Number (DN), continued

	DN	DATA ELEMENT NAME	CATEGORY
CA	0036	Part of Body Injured Code	Accident
CA	0037	Cause of Injury Code	Accident
CA	0038	Accident Description/Cause	Accident
CA	0039	Initial Treatment Code	Accident
CA	0040	Date Reported to Employer	Accident
CA	0041	Date Reported to Claim Administrator	Accident
CA	0042	Social Security Number	Employee
CA	0043	Employee Last Name	Employee
CA	0044	Employee First Name	Employee
CA	0045	Employee Middle Name/Initial	Employee
CA	0046	Employee Address Line 1	Employee
CA	0047	Employee Address Line 2	Employee
CA	0048	Employee City	Employee
CA	0049	Employee State Code	Employee
CA	0050	Employee Postal Code	Employee
CA	0051	Employee Phone Number	Employee
CA	0052	Employee Date of Birth	Employee
CA	0053	Gender Code	Employee
CA	0054	Marital Status Code	Employee
CA	0055	Number of Dependents	Employee
CA	0056	Date Disability Began	Employee
CA	0057	Employee Date of Death	Employee
CA	0058	Employment Status Code	Employment
CA	0059	Class Code	Employment
CA	0060	Occupation Description	Employment
CA	0061	Date of Hire	Employment
CA	0062	Wage	Employment
CA	0063	Wage Period Code	Employment
	0064	Number of Days Worked	
CA	0065	Date Last Day Worked	Employment
	0066	Full Wages Paid for Date of Injury Indicator	
CA	0067	Salary Continued Indicator	Employment
CA	0068	Date of Return to Work	Employee

~~November 15, 2011~~ (DATE TO BE INSERTED BY OAL - 6 ~~12~~ MONTHS FOLLOWING APPROVAL AND FILING WITH SECRETARY OF STATE)

FROI Data Elements, Sorted Alphabetically

	Release 1 - FROI - 148	CATEGORY: FROI Data
DN	DATA ELEMENT NAME	Requirements Table
CA	0038 Accident Description/Cause	Accident
CA	0005 Agency Claim Number/Jurisdiction Claim Number	Claim
CA	0037 Cause of Injury Code	Accident
CA	0010 Claim Administrator Address Line 1	Claim Administrator
CA	0011 Claim Administrator Address Line 2	Claim Administrator
CA	0012 Claim Administrator City	Claim Administrator
CA	0015 Claim Administrator Claim Number	Claim
<u>CA</u>	<u>0008 Claim Administrator FEIN</u>	<u>Claim Administrator</u>
<u>CA</u>	<u>0009 Claim Administrator Name</u>	<u>Claim Administrator</u>
CA	0014 Claim Administrator Postal Code	Claim Administrator
CA	0013 Claim Administrator State Code	Claim Administrator
CA	0059 Class Code	Employment
CA	0056 Date Disability Began	Employee
CA	0065 Date Last Day Worked	Employment
CA	0061 Date of Hire	Employment
CA	0031 Date of Injury	Accident
CA	0068 Date of Return to Work	Employee
CA	0041 Date Reported to Claim Administrator	Accident
CA	0040 Date Reported to Employer	Accident
CA	0046 Employee Address Line 1	Employee
CA	0047 Employee Address Line 2	Employee
CA	0048 Employee City	Employee
CA	0052 Employee Date of Birth	Employee
CA	0057 Employee Date of Death	Employee
CA	0044 Employee First Name	Employee
CA	0043 Employee Last Name	Employee
CA	0045 Employee Middle Name/Initial	Employee
CA	0051 Employee Phone Number	Employee
CA	0050 Employee Postal Code	Employee
CA	0049 Employee State Code	Employee
CA	0019 Employer Address Line 1	Employer
CA	0020 Employer Address Line 2	Employer
CA	0021 Employer City	Employer
CA	0016 Employer FEIN	Employer
CA	0018 Employer Name	Employer
CA	0023 Employer Postal Code	Employer

~~November 15, 2011~~ (DATE TO BE INSERTED BY OAL - 6 ~~12~~ MONTHS FOLLOWING APPROVAL AND FILING WITH SECRETARY OF STATE)

CA	0022	Employer State Code	Employer
	0034	Employer's Premises Indicator	

FROI Data Elements, Sorted Alphabetically, continued

DN	DATA ELEMENT NAME	CATEGORY	
CA	0058	Employment Status Code	Employment
	0066	Full Wages Paid for Date of Injury Indicator	
CA	0053	Gender Code	Employee
CA	0025	Industry Code	Employer
CA	0039	Initial Treatment Code	Accident
	0027	Insured Location Number	
	0017	Insured Name	
CA	0026	Insured Report Number	Claim
CA	0006	Insurer FEIN	Insurer
CA	0007	Insurer Name	Insurer
CA	0004	Jurisdiction Code	Jurisdiction
CA	0002	Maintenance Type Code	Transaction
CA	0003	Maintenance Type Code Date	Transaction
CA	0054	Marital Status Code	Employee
CA	0035	Nature of Injury Code	Accident
	0064	Number of Days Worked	
CA	0055	Number of Dependents	Employee
CA	0060	Occupation Description	Employment
CA	0036	Part of Body Injured Code	Accident
CA	0029	Policy Effective Date	Claim
CA	0030	Policy Expiration Date	Claim
CA	0028	Policy Number	Claim
CA	0033	Postal Code of Injury Site	Accident
CA	0067	Salary Continued Indicator	Employment
CA	0024	Self-Insured Indicator	Employer
CA	0042	Social Security Number	Employee
CA	0008	Third Party Administrator FEIN	Claim Administrator
CA	0009	Third Party Administrator Name	Claim Administrator
CA	0032	Time of Injury	Accident
CA	0001	Transaction Set ID	Transaction
CA	0062	Wage	Employment
CA	0063	Wage Period Code	Employment

SROI Data Elements, Sorted By Data Element Number (DN)

Release 1 - SROI - A49			CATEGORY: SROI Data
DN	DATA ELEMENT NAME		Requirements Table
CA	0001	Transaction Set ID	Transaction
CA	0002	Maintenance Type Code	Transaction
CA	0003	Maintenance Type Code Date	Transaction
CA	0004	Jurisdiction Code	Jurisdiction
CA	0005	Agency Claim Number/Jurisdiction Claim Number	Claim
CA	0006	Insurer FEIN	Insurer
CA	0008	Third Party <u>Claim</u> Administrator FEIN	Claim Administrator
CA	0014	Claim Administrator Postal Code	Claim Administrator
CA	0015	Claim Administrator Claim Number	Claim
CA	0026	Insured Report Number	Claim
CA	0031	Date of Injury	Accident
CA	0042	Social Security Number	Employee
CA	0055	Number of Dependents	Employee
CA	0056	Date Disability Began	Employee
CA	0057	Employee Date of Death	Employee
CA	0062	Wage	Employment
CA	0063	Wage Period Code	Employment
	0064	Number of Days Worked	
CA	0067	Salary Continued Indicator	Employment
	0069	Pre-Existing Disability Code	
CA	0070	Date of Maximum Medical Improvement	Employee
CA	0071	Return to Work Qualifier	Employee
CA	0072	Date of Return/Release to Work	Employee
CA	0073	Claim Status Code	Claim
CA	0074	Claim Type Code	Claim
	0075	Agreement to Compensate Code	
CA	0076	Date of Representation	Claim
CA	0077	Late Reason Code	Payments
CA	0078	Number of Permanent Impairments	Variable Segment
CA	0079	Number of Payments/Adjustments	Variable Segment
CA	0080	Number of Benefit Adjustments	Variable Segment
CA	0081	Number of Paid To Date/Reduced Earnings/Recoveries	Variable Segment
CA	0082	Number of Death Dependent/Payee Relationships	Variable Segment
CA	0083	Permanent Impairment Body Part Code	Permanent Impairments
CA	0084	Permanent Impairment Percentage	Permanent Impairments
CA	0085	Payment/Adjustment Code	Benefit Payments

SROI Data Elements, Sorted By Data Element Number (DN), continued

	DN	DATA ELEMENT NAME	CATEGORY
CA	0086	Payment/Adjustment Paid to Date	Benefit Payments
CA	0087	Payment/Adjustment Weekly Amount	Benefit Payments
CA	0088	Payment/Adjustment Start Date	Benefit Payments
CA	0089	Payment/Adjustment End Date	Benefit Payments
CA	0090	Payment/Adjustment Weeks Paid	Benefit Payments
CA	0091	Payment/Adjustment Days Paid	Benefit Payments
CA	0092	Benefit Adjustment Code	Benefit Adjustments
CA	0093	Benefit Adjustment Weekly Amount	Benefit Adjustments
CA	0094	Benefit Adjustment Start Date	Benefit Adjustments
CA	0095	Paid to Date/Reduced Earnings/Recoveries Code	Paid to Date
CA	0096	Paid to Date/Reduced Earnings/Recoveries Amount	Paid to Date
	0097	Dependent/Payee Relationship Code	

SROI Data Elements, Sorted Alphabetically

	Release 1 - SROI - A49		CATEGORY: SROI Data Requirements Table
	DN	DATA ELEMENT NAME	
CA	0005	Agency Claim Number/Jurisdiction Claim Number	Claim
	0075	Agreement to Compensate Code	
CA	0092	Benefit Adjustment Code	Benefit Adjustments
CA	0094	Benefit Adjustment Start Date	Benefit Adjustments
CA	0093	Benefit Adjustment Weekly Amount	Benefit Adjustments
CA	0015	Claim Administrator Claim Number	Claim
CA	0008	Claim Administrator FEIN	Claim Administrator
CA	0014	Claim Administrator Postal Code	Claim Administrator
CA	0073	Claim Status Code	Claim
CA	0074	Claim Type Code	Claim
CA	0056	Date Disability Began	Employee
CA	0031	Date of Injury	Accident
CA	0070	Date of Maximum Medical Improvement	Employee
CA	0076	Date of Representation	Claim
CA	0072	Date of Return/Release to Work	Employee
	0097	Dependent/Payee Relationship Code	
CA	0057	Employee Date of Death	Employee

~~November 15, 2011~~ (DATE TO BE INSERTED BY OAL - ~~6~~ 12 MONTHS FOLLOWING APPROVAL AND FILING WITH SECRETARY OF STATE)

CA	0026	Insured Report Number	Claim
CA	0006	Insurer FEIN	Insurer
CA	0004	Jurisdiction Code	Jurisdiction
CA	0077	Late Reason Code	Payments

SROI Data Elements, Sorted Alphabetically, continued

DN	DATA ELEMENT NAME	CATEGORY	
CA	0002	Maintenance Type Code	Transaction
CA	0003	Maintenance Type Code Date	Transaction
CA	0080	Number of Benefit Adjustments	Variable Segment
	0064	Number of Days Worked	
CA	0082	Number of Death Dependent/Payee Relationships	Variable Segment
CA	0055	Number of Dependents	Employee
CA	0081	Number of Paid To Date/Reduced Earnings/Recoveries	Variable Segment
CA	0079	Number of Payments/Adjustments	Variable Segment
CA	0078	Number of Permanent Impairments	Variable Segment
CA	0096	Paid to Date/Reduced Earnings/Recoveries Amount	Paid to Date
CA	0095	Paid to Date/Reduced Earnings/Recoveries Code	Paid to Date
CA	0085	Payment/Adjustment Code	Benefit Payments
CA	0091	Payment/Adjustment Days Paid	Benefit Payments
CA	0089	Payment/Adjustment End Date	Benefit Payments
CA	0086	Payment/Adjustment Paid to Date	Benefit Payments
CA	0088	Payment/Adjustment Start Date	Benefit Payments
CA	0087	Payment/Adjustment Weekly Amount	Benefit Payments
CA	0090	Payment/Adjustment Weeks Paid	Benefit Payments
CA	0083	Permanent Impairment Body Part Code	Permanent Impairments
CA	0084	Permanent Impairment Percentage	Permanent Impairments
	0069	Pre-Existing Disability Code	
CA	0071	Return to Work Qualifier	Employee
CA	0067	Salary Continued Indicator	Employment
CA	0042	Social Security Number	Employee
CA	0008	Third Party Administrator FEIN	Claim Administrator
CA	0001	Transaction Set ID	Transaction
CA	0062	Wage	Employment
CA	0063	Wage Period Code	Employment

Section M: System Specifications

Agency Claim Number/Jurisdiction Claim Number (JCN)

The Agency Claim Number (DN5) is most often referred to as the Jurisdiction Claim Number (JCN). The JCN is created by WCIS to uniquely identify each claim. It is provided to the claims administrator on their acknowledgment of the First Report. The JCN is required on all FROI and SROI Transactions with the exception of the FROI 00, 04 and AU. Before the WCIS system was revised in July 2004 the original WCIS system created a 12-digit JCN. The revised system is backwards compatible and will continue to accept the 12-digit JCN for claims originally reported to the old system. **All new claims reported to the revised system will receive a 22-digit JCN.**

Changed or Corrected Data

The WCIS regulations require each claim administrator to submit to WCIS any changed or corrected data elements. ~~Changed or corrected data for a claim are due by the time of the next submission for the claim. Correction reports (MTC=CO) are sent in response to a TE (transaction accepted with error) acknowledgment from WCIS. Change Reports (MTC=02) are sent when either the data in a previously submitted report was incomplete, or when the claim administrator becomes aware that the value of a previously reported data element has changed, e.g., Employee Address. If the data in a previously submitted first report was incomplete, then a Change Report should be submitted within 30 60 calendar days of the original first report submission. If the data in a previously submitted first report has changed, then a Change Report should be submitted by the next date a submission is due on the claim. Correction Reports (MTC=CO) are sent in response to a TE (transaction accepted with error) acknowledgment from WCIS. Correction Reports are due within 30 60 calendar days of original TE acknowledgment. If a claim administrator needs to make changes to some data elements while making corrections to other elements for a given claim, these can the changes and corrections should be combined on either a change or on a eCorrection fReport with identical results.~~

When submitting a eChange or eCorrection fReport, the claim administrator should resubmit all known data elements, not just the data elements being changed or corrected. Data elements missing in a resubmission will not cause valid data already existing in the database to be overwritten; however the claim administrator will receive errors if the missing data elements are necessary for validation purposes. For example, if the Employee Date of Birth is absent on the eChange or eCorrection fReport, WCIS will not delete the Date of Birth stored in the WCIS database, but the claim administrator will receive an error for having a mandatory data element missing.

When submitting a Correction Report (MTC=CO), the MTC Date must be the date of the original transaction that is being corrected.

Transaction Processing and Sequencing

General Rules

The WCIS processes batches within a transmission in the order in which they are received. If submitting more than one transaction for a single claim in the same batch or transmission, it is important that WCIS receive the transactions in the proper sequence. Transactions should be submitted in logical business order or in the order they were entered into the claim administrator's system, according to the following general rules:

- The First Report for a claim must be submitted and processed by WCIS before any Subsequent Reports are submitted for the claim. Subsequent Reports sent before the corresponding First Report has been received by WCIS will be rejected.

First Report and Subsequent Report transactions must be submitted in separate batches by default. Combining First and Subsequent Reports in a batch is impossible because the two types of reports have different field layouts. If a First Report batch and Subsequent Report batch with the same claims are submitted to WCIS on the same day, the Subsequent Reports may be rejected. The WCIS will not automatically process the First Reports first. In order to avoid sequencing errors with First and Subsequent reports it is best to submit the reports on separate days.

- Incoming transactions with Maintenance Type Code (MTC) dates, DN3, that are later than the current processing date (system date) will be rejected. For example, a transaction with an MTC date of 11-01-03 that is processed on 10-31-03 will be rejected. In addition, the MTC date must be between '1900' and the current date.

If the claim administrator is not sure of the business order, the following general sort orders are suggested:

- Primary sort order is MTC date. Multiple transactions for a claim should be sorted by MTC date so that WCIS processes the oldest MTC date first. This will help avoid unnecessary sequencing errors.
- Secondary sort order is MTC code. MTC codes should be sorted in business event order. See the next sections for further explanations specific to First Reports and Subsequent Reports.

First Reports

This section is intended to aid you in understanding the general sequence or order in which Maintenance Type Codes may be used to report claim events for First Reports. Maintenance Type Codes are used to define the specific purpose of a transaction. There are two types of First Report Maintenance Type Codes, initial First Reports, the very first report sent; and other First Reports, not the initial first report sent. Some Maintenance Type Codes belong in both groups; they can be the initial First Report sent or they can be sent after the initial First Report. Some Maintenance Type Codes can only be other First Reports and must be preceded by an initial First Report. First Report Maintenance Type Codes are grouped in the following tables to clarify their purpose and to demonstrate a logical order for their use. If transactions for a claim are not received in the proper sequence, whether they are submitted in one transmission or several, they will be rejected. If transactions are rejected due to processing/sequencing errors, then the claim administrator is responsible for resubmitting the transactions.

Initial First Reports: These Maintenance Type Codes are used to report new claims. One of these Maintenance Type Codes must be the initial First Report sent to WCIS.

MTC Code	MTC Name
00	Original
04	Denial
AU	Acquired/Unallocated*

*Any existing indemnity benefits will automatically be suspended when the FROI Acquired Unallocated (MTC=AU) is accepted.

Other First Reports: After the initial First Report has been filed, the following First Report Maintenance Type Codes can be submitted to reflect/report additional information about the claim not known at the time of original reporting.

MTC Code	MTC Name
01	Cancel
02	Change
04	Denial
CO	Correction

First Report Transaction Sequencing Requirements Summary

MTC	Description	Type	Sequence Requirements
00	Original	Initial	None
AU	Acquired/Unallocated	Initial	None
04	Denial	Initial/Other	None
01	Cancel	Other	Must follow <u>initial</u> First Report
CO	Correction	Other	Must follow <u>initial</u> First Report
02	Change	Other	Must follow <u>initial</u> First Report

Subsequent Reports

For Subsequent Reports, each Maintenance Type Code identifies a Benefit Event – an action occurring on one or more benefit types. Benefit Events are of three main types: (1) Open Benefits: the claim administrator is starting to pay ongoing benefits; (2) Close Benefits: the claim administrator is suspending ongoing benefit payments; (3) Update Benefit: the claim administrator is reporting a change to a benefit period that has already been reported to WCIS. In the tables below, Maintenance Type Codes are grouped by the Benefit Event Type or the action that is being performed on the benefit. The transaction sequencing rules in the next section are applied at the Benefit Event Type level and not the specific Maintenance Type Code.

Open Benefits: These Maintenance Type Codes are used to report the start of a benefit period.

MTC Code	MTC Name
IP	Initial Payment*
AP	Acquired Payment
FS	Full Salary
RB	Reinstatement of Benefits
CB	Change Benefit
AN	Annual**
FN	Final**

Only one IP transaction for the same Claim Number claim will be allowed. Additional IPs will be rejected. New benefits can be added with CB, RB, and PY.

~~**For indemnity claims, must be preceded by a SROI-IP or AP, CD, FS, or PY, as applicable~~

Close Benefits: These Maintenance Type Codes are used to report the ending of a benefit period.

MTC Code	MTC Name
PJ, P1-9	Partial Suspension
SJ, S1-9	Suspension
04	Denial
4P	Partial Denial*
CB	Change Benefit
CD	Compensatory Death**

* 4P is sent when a specific benefit is being denied. If a benefit that has not been paid is being denied, the benefit should not be reported on the 4P, due to limits in the IAIABC specifications.

** CD automatically closes all open indemnity benefits.

Update Benefits: These Maintenance Type Codes are used to report an update to a previously reported benefit period.

MTC Code	MTC Name
CA	Change in Benefit Amount
RE	Reduced Earnings
02	Change
CO	Correction

Other: These Maintenance Type codes don't fall into the above categories. They don't open, close, or update benefits in the same manner as other Maintenance Type Codes, because (1) the MTC reports single, lump sum payments (PY) rather than the payment of ongoing benefits, or (2) the MTC has specific jurisdictional uses (UR) or (3) the MTC reports the closing of a claim (FN).

MTC Code	MTC Name
PY	Payment Report
UR	Upon Request
<u>AN*</u>	<u>Annual**</u>
<u>FN-FN**</u>	<u>Final Report-Final Report</u>

* For indemnity claims, must be preceded by a FROI AU, SROI IP or AP, CD, FS, or PY, as applicable.

Reporting Advances and Settlements

An Initial Payment (IP) A Payment Report (PY) should be sent to report an advance or settlement that is the first indemnity payment. The Payment Report (PY) can also be used to report an advance or settlement after the IP.

Advances should be reported using the appropriate Payment/Adjustment Codes (DN85). For example, a permanent disability advance would be reported using the payment/adjustment code 030 and a temporary disability advance for a Qualified Medical Evaluation (QME) appointment would be reported using the payment/adjustment code 050.

Some settlements, such as those found in a Compromise and Release (C&R) or a commutation, are paid as a one-time, lump sum amount; others, such as a stipulated settlement, allow for a future, ongoing payment stream. Settlements should be reported using the appropriate 5xx compromised Payment/Adjustment (DN85) codes and, if applicable, the appropriate Paid to Date (DN95) codes for each portion of the settlement. Compromised codes used for settlements in the WCIS are listed in Section N – Code Lists.

It is important to understand that the sum of the 5xx codes submitted for a particular settlement should equal the total settlement amount, less any advances already paid. For example, if a total, lump sum C&R settlement of \$20,000 consisted of \$15,000 for compromised permanent disability, \$3,000 for compromised medical and \$2,000 for attorney fees, then the settlement should be reported under Payment/Adjustment Code 530 (DN85), using benefit type codes:

- 530, with the amount \$15,000
- 501, with the amount \$3,000 and
- 500, with the amount \$2,000.

Ideally, the attorney fees should also be reported under the Paid to Date Code (DN95) benefit type code 340, with the amount \$2,000. If a C&R or a commutation settlement cannot be broken down by each portion of the settlement and assigned to compromised benefit codes, then the entire settlement amount of \$20,000 should be reported under Payment/Adjustment Code DN85, benefit type code 500 – Unspecified. For settlements that are paid as a lump sum, the Payment/Adjustment Start and End Dates (DNs 88 and 89) should equal the settlement date.

For stipulated settlements that are ongoing, only the first and last payments need to be reported. On the initial stipulated settlement payment, the Payment/Adjustment Start Date ~~should equal the settlement date~~ and the End Date ~~should be the last through date for the first payment period of the settlement cover the payment period for the initial stipulated payment~~. On the last stipulated settlement payment, the Start and End Dates should cover the last payment period of the settlement.

Periodic Reports:

Periodic Reports are required for every claim with any benefit type including medical. Periodic Reports should not be used to report that a benefit period is opening, closing, or being updated. Rather, they are sent at a specific time in the life of a claim to report the amount paid for all benefit types and other benefit types through that date.

MTC Code	MTC Name
AN*	Annual

For indemnity claims, must be preceded by a FROI AU, SROI IP or AP, CD, FS, or PY, as applicable.

For non-indemnity claims, i.e., claims without indemnity payments, a sufficient final report would be the Annual transaction (AN) with the Claim Status (DN73) set to “closed”. A Final transaction (FN) need not be sent.

An Annual Summary of Benefits must be submitted for every claim with any benefit activity (including medical) during the preceding calendar year. The annual summary report is due by January 31 and must report the cumulative totals of any benefits paid as of December 31 of the preceding calendar year.

NOTE:

- If submitting ANs in ANSI X12 format, be sure to include the proper ANSI frequency code. If you have any questions, contact your EDI liaison.
- Annual transactions must contain at least one type of benefit payment.

Transaction Sequencing Requirements for Subsequent Reports

A general principle for WCIS is that we only want to collect data that we can interpret. To assure this, Subsequent Reports are automatically subjected to a set of sequencing rules and related business rules when processed by WCIS. The sequencing requirements for Subsequent Reports are given in the table below.

Sequencing Rules

Benefit-Level MTC	Benefit Event Type	Benefit Event Processing Rules to Be Applied
02, CO	Update	Allow All
AN, FN	Periodic	Allow all
UR, PY, CD*	Other	Allow All

* CD automatically closes all open indemnity benefits.

Related Business Rules

Rules Specific to Transaction-Level MTC

These rules are applied at the transaction level of the Maintenance Type Code. If any of these rules are not met, the transaction will be rejected.

Transaction MTC	Rule
CA , CB, RB, Px, and Sx (and MTCs 02, CO with benefit blocks)	Must be preceded by at least one previous benefit event of any Payment/Adjustment Code (DN85).

present)	
FS	Must contain a benefit record with Payment/Adjustment Code (DN85) = 240 or 524
<u>AN and FN</u>	<u>For Indemnity claims, the AN and FN must be preceded by a IP, AP, CD, FS, or PY, as applicable.</u>
<u>SROI 02 and SROI CO</u>	<u>The Claim Status (DN 73) or Date of Representation (DN 76) must be present when there are no benefits being reported.</u>
Any MTC not supported in Benefit Event Type Rules table (including VE)	Reject transaction.

Overall Transaction Structure Edits.

(1) No benefit blocks (or “other benefits”, credits, adjustments, or reduced earnings blocks) are expected for First Report of Injury Reports (transactions with Maintenance Type Codes 00, 01, or AU). The transaction will be rejected if benefit blocks are reported on the First Report.

(2) Benefit blocks within a transaction may not repeat the same benefit code. Transactions will be rejected if duplicate benefit codes are reported in the same transaction.

WCIS Matching Rules and Processes

Match Data for a Claim

Primary:

1. ~~Agency Claim Number/Jurisdiction Claim Number, DN5~~

Secondary Match for Reports OTHER THAN AU:

2a. ~~Insurer FEIN (DN6)~~

~~AND Third Party Administrator FEIN (DN8), if any,~~

~~AND Claim Administrator Claim Number (DN15)~~

Alternative Secondary Match for AU:

2b. ~~Date of Injury (DN31)~~

~~AND Nature of Injury Code (DN35)~~

~~AND Part of Body Injured Code (DN36)~~

~~AND Employee Last Name (DN43)
AND Employee First Name (DN44)~~

How WCIS Matches Incoming Transactions to Existing Claim Records

FROI/SROI uses the following key data elements to match and search for duplicate claims within the WCIS database:

- Jurisdiction Claim Number (JCN) (DN 5)
- Insurer FEIN (INS_FEIN) (DN 6)
- Claim Administrator FEIN (CA_FEIN) (DN 8)
- Claim Administrator Claim Number (CLAIM_NUM) (DN 15)
- Date of Injury (DOI) (DN 31)
- Employee Date of Birth (DOB) (DN 52)
- First two characters of the Employee First Name (DN 44)
- Employer FEIN (EMP_FEIN) (DN 16)
- Time of Injury (TOI) (DN 32) For Dates of Injury after Implementation of FROI/SROI Release 1 Version 3.1

~~The WCIS uses the Agency Claim Number/Jurisdiction Claim Number (JCN) as the primary means for matching transactions representing the same claim. Secondary match data will be used only if a JCN is not provided. For current JCN requirements please see Jurisdiction Claim Number earlier in this section.~~

~~Transactions that can never be initial First Reports (MTC = 01, 02, CO, and all subsequent reports) will be rejected if they cannot be matched to existing claims on the WCIS database. This matching is based on the JCN, if provided. Otherwise, secondary match data #2a (described above) will be used.~~

~~For transaction types that may or may not be initial First Reports (MTC = 00, 04), secondary match data is used to help avoid creation of duplicate records. Secondary match data #2a is used to prevent a given claim administrator from reporting multiple claims with the same Claim Administrator Claim Number and the same insurer.~~

~~The claim administrator can only change the data elements in match data #2a and #2b when a JCN is provided.~~

~~The case of a claim administrator acquiring existing claims from another administrator requires special handling. This is necessary because the claim administrator acquiring the claim may not know the JCN, and secondary match data #2a won't be useful for matching such transactions (because a new Third Party Administrator or Insurer FEIN and Claim Administrator Claim Number will generally be provided when transferring claim ownership). Therefore, for acquired reports (MTC=AU) only, the WCIS will use alternative match data #2b to~~

determine if an AU transaction lacking the JCN matches to an existing claim on the database.

FROI Matching Process for Original '00' MTC

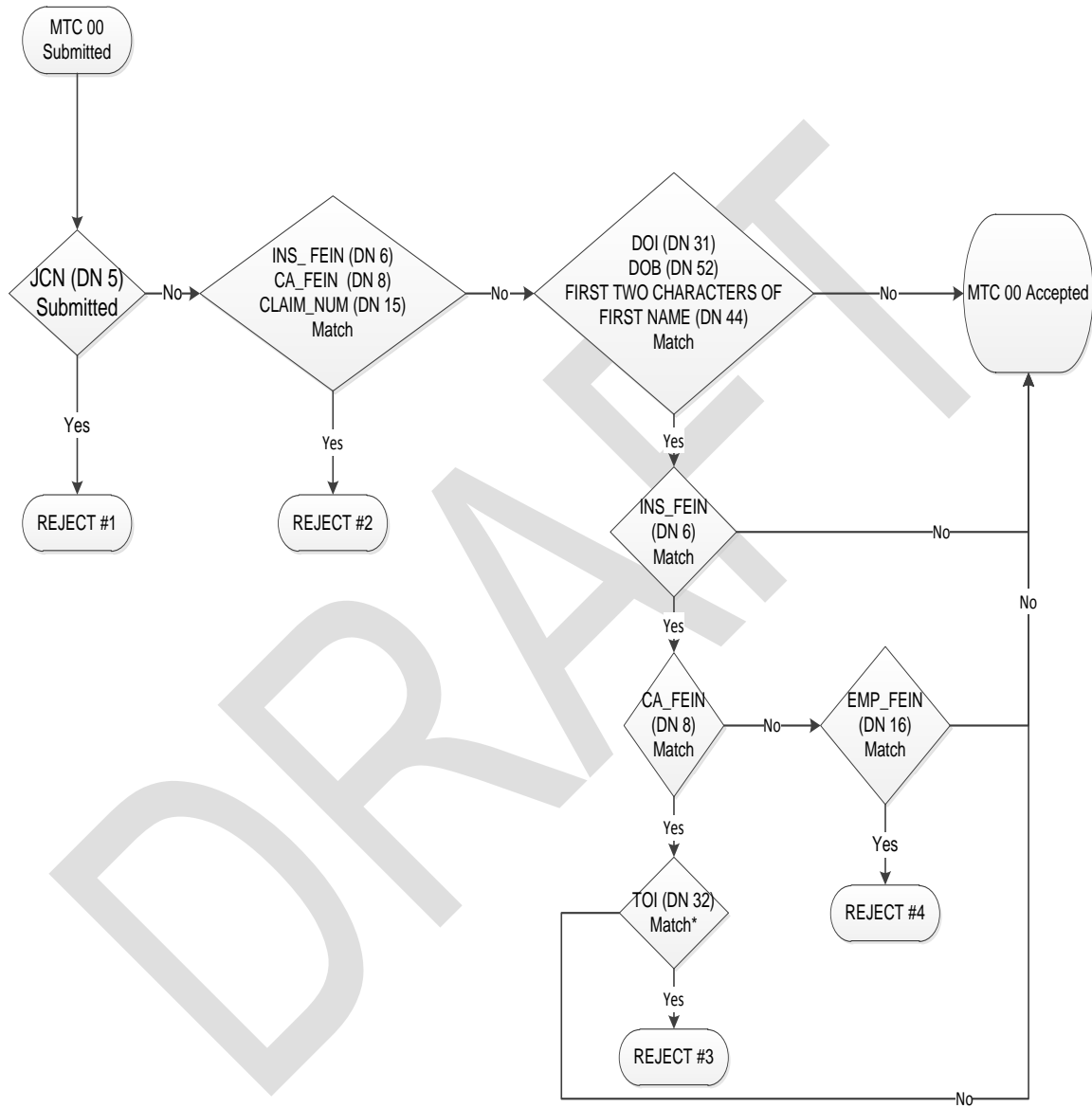

*TOI match and rejection only for claims with date of injury after implementation date for FROI/SROI Release 1 Version 3.1

Reject Reasons:

Reject #1 JCN not allowed on '00'. Error Code 061 Event Criteria Not Met.

Reject #2 Duplicate FROI found. Error Code 048 Duplicate First Report (148).

Reject #3 Duplicate injury or claim found. Error Code 048 Duplicate First Report (148).

Reject #4 Transaction must be submitted as an AU. Error Code 048 Duplicate First Report (148).

DRAFT

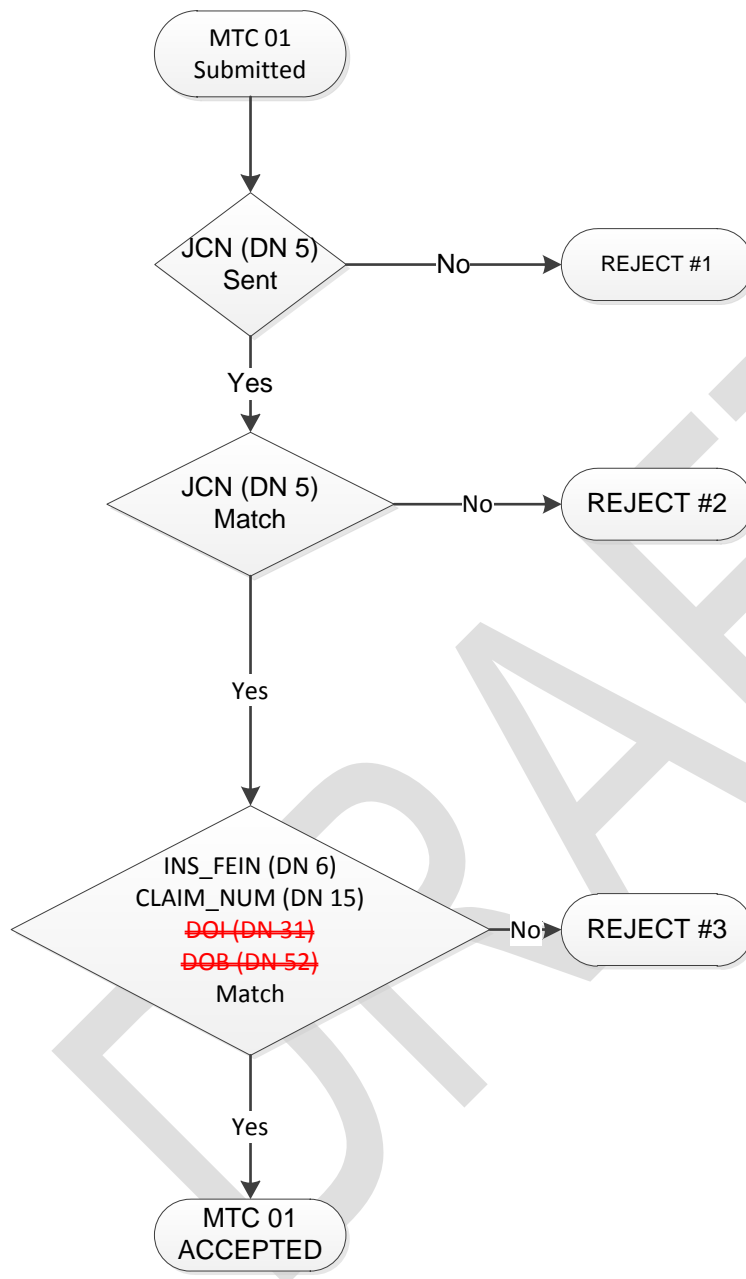
FROI Matching Process for Cancel '01' MTC**Reject Reasons:**

Reject #1 JCN is mandatory. Error Code 001 Mandatory Field Not Present.

Reject #2 JCN must match existing JCN. Error Code 039 No Match on Database.

Reject #3 Claim information does not match a claim in the database. Error Code 039 No Match on Database.

FROI Matching Process for Change '02' or Correction 'CO' MTC

On a FROI '02' change or FROI 'CO' correction, all key data elements cannot be changed in the same transaction. Claim administrator claim number (DN 15) can only be changed if insurer FEIN (DN 6), date of injury (DN 31) and employee date of birth (DN 52) remain the same. If a valid JCN (DN 5) is submitted with a valid claim administrator claim number (DN 15), a 02 or CO transaction can change or correct any other field.

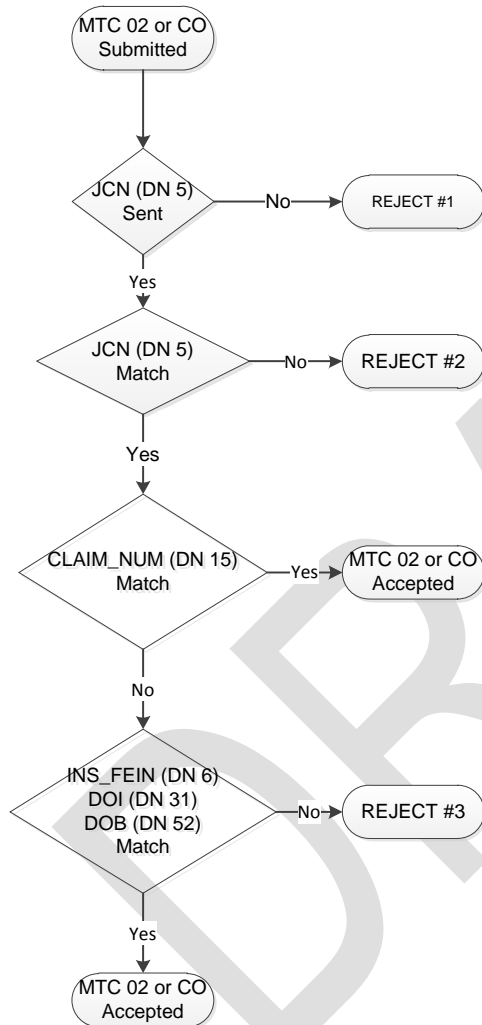

Reject Reasons:

Reject #1 JCN is mandatory. Error Code 001 Mandatory Field Not Present.

Reject #2 JCN must match existing JCN. Error Code 039 No Match on Database.

Reject #3 Claim information does not match a claim in the database. Error Code 039 No Match on Database.

FROI Matching Process for Denial '04' MTC

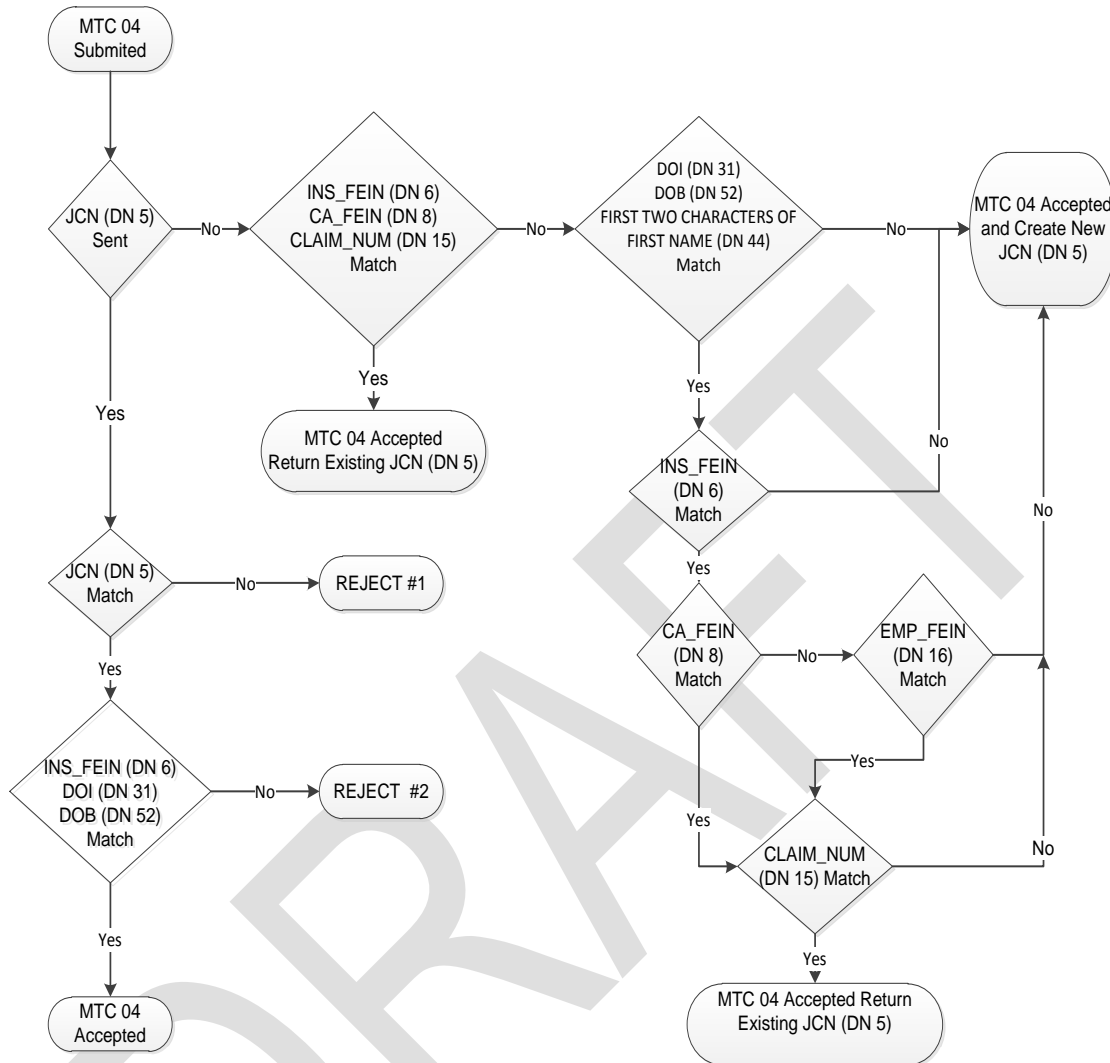

Reject Reasons:

Reject #1 JCN must match existing JCN. Error Code 039 No Match on Database.

Reject #2 Claim information does not match a claim in the database. Error Code 039 No Match on Database.

Acquired Claims

WCIS will support the transfer of claims from one claim administrator to another using the AU transaction. The AU will be processed as shown in the following chart.

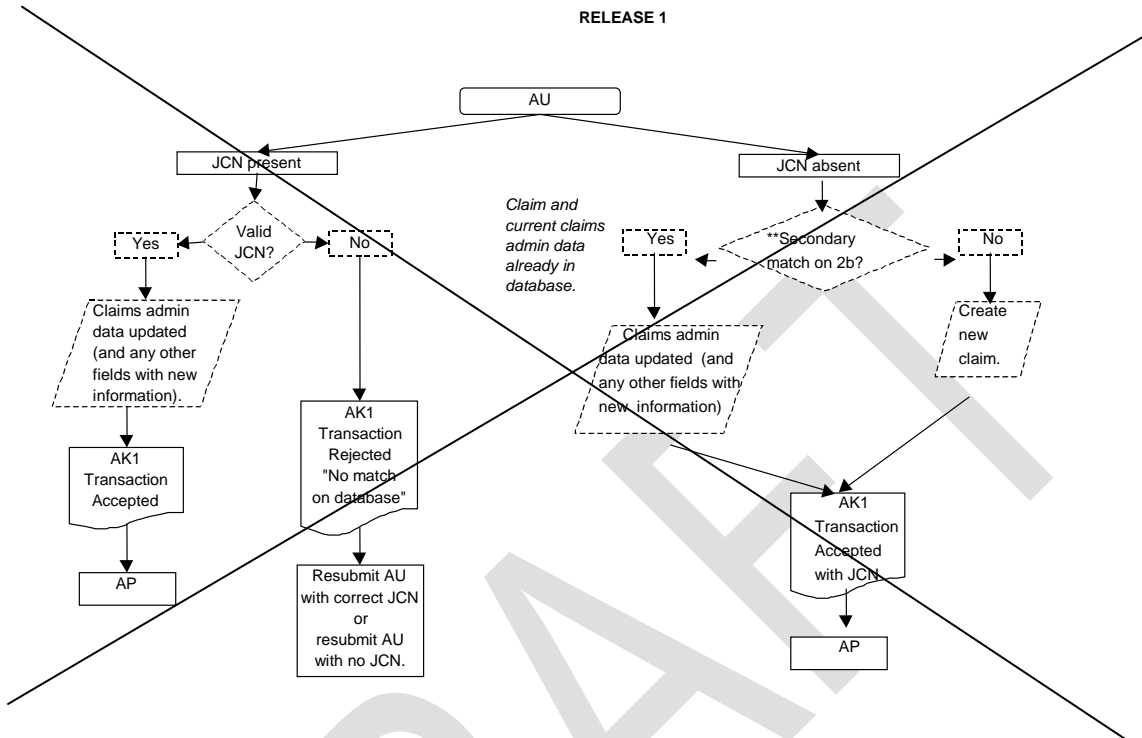

Boxes with solid straight lines indicate a transmission from the Trading Partner to WCIS. Boxes with a wavy bottom line indicate acknowledgments from WCIS to the Trading Partner. Boxes with dashed lines ----- indicate processing performed by WCIS.

**Secondary match on 2b, fields:

1. Date of Injury (DN31); AND
2. Part of Body Injured Code (DN36); AND
3. Nature of Injury Code (DN35); AND
4. Employee First Name (DN44); AND
5. Employee Last Name (DN43)

FROI Matching Process for Acquired Claim 'AU' MTC

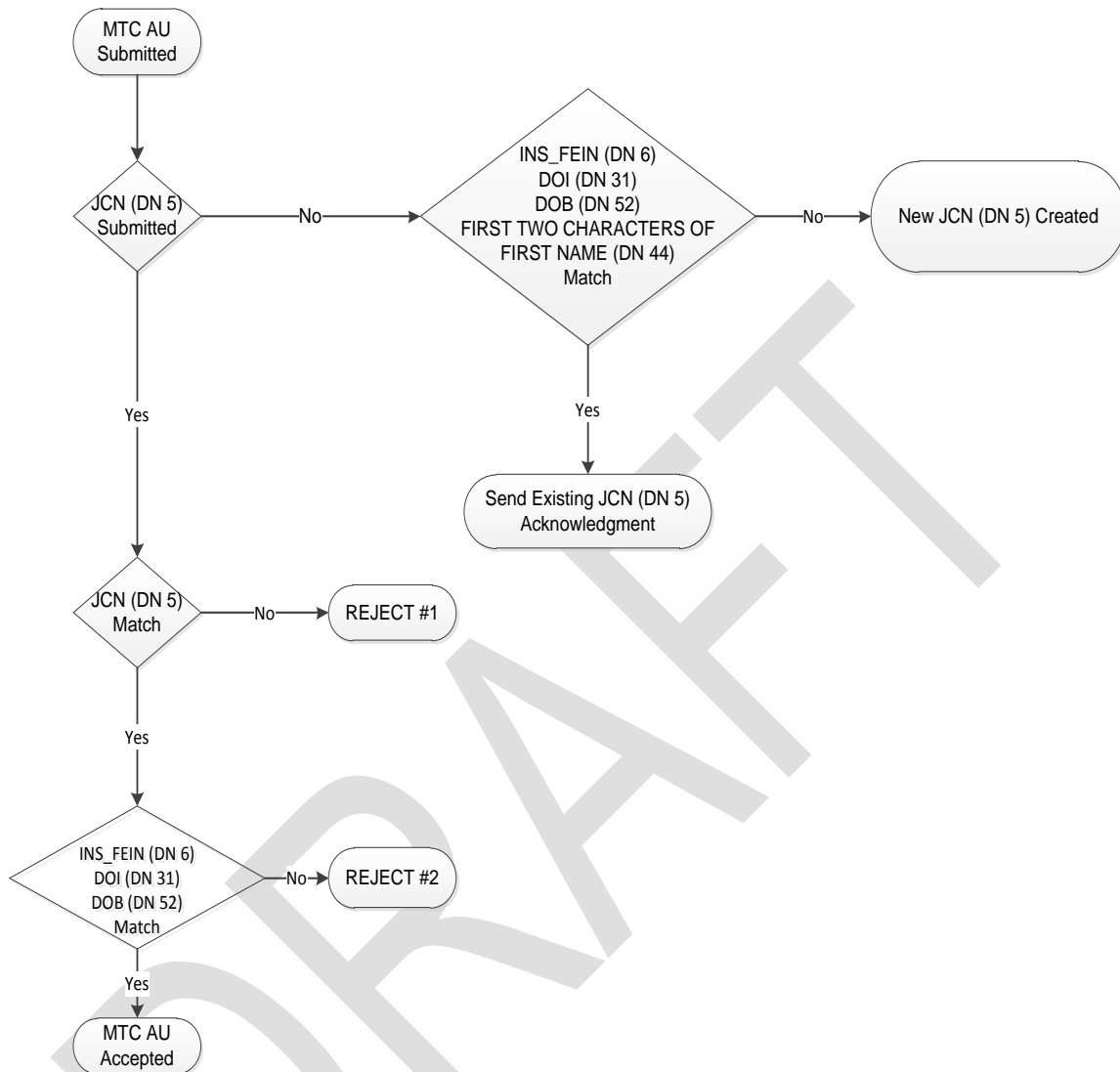

Reject Reasons:

Reject #1 JCN must match existing JCN. Error Code Error Code 039 No Match on Database.

Reject #2 Claim information does not match a claim in the database. Error Code 039 No Match on Database.

SROI Matching Process for All SROI MTCs

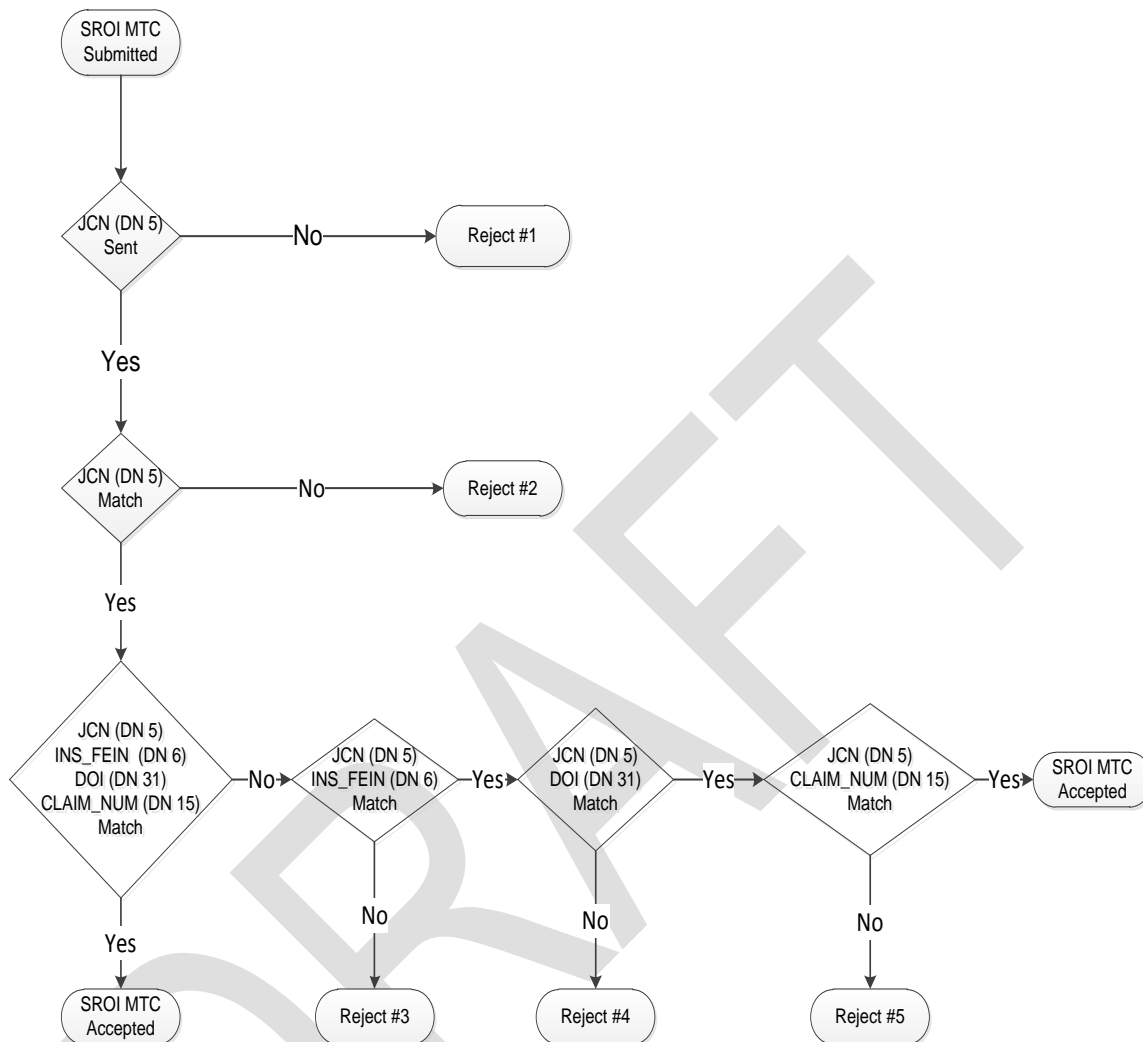

Reject Reasons:

Reject #1 JCN is mandatory. Error Code 001 Mandatory Field Not Present.

Reject #2 JCN must match existing JCN. Error Code 039 No Match on Database.

Reject #3 JCN and Insurer FEIN do not match database. Error Code 039 No Match on Database.

Reject #4 JCN and DOI do not match database. Error Code 039 No Match on Database.

Reject #5 JCN and Claim do not match database. Error Code 039 No Match on Database.

Section N: Code Lists

This Section lists ~~describes~~ valid codes for several data elements. The original source of each code list is noted. ~~These valid code lists are provided as a convenience for our data providers, and are intended to be a simple repetition of code lists available elsewhere. In no case have codes been purposely omitted or deleted.~~ If at any time you believe that WCIS is rejecting a valid code, please let us know by sending an e-mail to: wcis@dir.ca.gov.

Nature of Injury Codes (DN35)

Part of Body Codes (FROI DN36) and SROI (DN83)

Cause of Injury Codes (DN37)

Source: IAIABC/NCCI/WCIO

<http://www.wcio.org/Document%20Library/InjuryDescriptionTablePage.aspx>

Nature of Injury Codes (DN35)

CODE	DESCRIPTION
SPECIFIC INJURY	
01	No Physical Injury
02	Amputation
03	Angina Pectoris
54	Asphyxiation
04	Burn
07	Concussion
10	Contusion
13	Crushing
16	Dislocation
19	Electric Shock
22	Enucleation (To Remove, Ex.: Tumor, Eye, etc)
25	Foreign Body
28	Fracture
30	Freezing
31	Hearing Loss or Impairment
32	Heat Prostration
34	Hernia
36	Infection
37	Inflammation
40	Laceration
41	Myocardial Infarction (Heart Attack)
42	Poisoning-General (Not OD or Cumulative Injury)
43	Puncture
46	Rupture

47	Severance
49	Sprain
52	Strain
53	Syncope
55	Vascular
58	Vision Loss
59	All Other Specific Injuries, NOC

Nature of Injury Codes (DN35) – continued	
CODE	DESCRIPTION
OCCUPATIONAL DISEASE OR CUMULATIVE INJURY	
60	Dust Disease, NOC (All other Pneumoconiosis)
61	Asbestosis
62	Black Lung
63	Byssinosis
64	Silicosis
65	Respiratory Disorders (Gases, Fumes, Chemicals, etc.)
66	Poisoning-Chemical (Other than Metals)
67	Poisoning-Metal
68	Dermatitis
69	Mental Disorder
70	Radiation
71	All Other Occupational Disease Injury, NOC
72	Loss of Hearing
73	Contagious Disease
74	Cancer
75	Aids
76	VDT-Related Disease
77	Mental Stress
78	Carpal Tunnel Syndrome
79	Hepatitis C
80	All Other Cumulative Injuries, NOC
MULTIPLE INJURIES	
90	Multiple Physical Injuries Only
91	Multiple Injuries Including Both Physical and Psychological

Source: IAIABC/NCCI/WCIO

<https://www.wcio.org/default.aspx>

Part of Body Codes: FROI (DN36) and SROI (DN83)

FROI CODE (DN36)	SROI CODE (DN83)	CODE DESCRIPTION
HEAD		
10	10	Multiple Head Injury
11	11	Skull
12	12	Brain
13	13	Ear(s)*
13	13A	Total Deafness of Both Ears*
13	13B	Total Deafness of One Ear*
13	13C	Where Worker Prior to Injury has Suffered a Total Loss of Hearing in One Ear, and as a Result of the Accident Loses Total Hearing in Remaining Ear*
14	14	Eye(s)*
14	14A	The Loss of Eye by Enucleation (Including Disfigurement Resulting from Removal)*
14	14B	Total Blindness of One Eye*
14	14C	Blindness in both Eyes*
15	15	Nose
16	16	Teeth
17	17	Mouth
18	18	Soft Tissue — Head
19	19	Facial Bones
NECK		
—20	—20	Multiple Neck Injury
21	21	Vertebrae
22	22	Disc
23	23	Spinal Cord
24	24	Larynx
25	25	Soft Tissue — Neck
26	26	Trachea
UPPER EXTREMITIES		
30	30	Multiple Upper Extremities
—31	—31	Upper Arm (Excluding Clavicle & Scapula)*
32	32	Elbow*
33	33	Lower Arm*
34	34	Wrist*
35	35	Hand*
36	36	Finger(s)*

* These bilateral body part codes can be reported twice under DN83, when applicable.

Part of Body Codes: FROI (DN36) and SROI (DN83) - Continued		
FROI CODE (DN36)	SROI CODE (DN83)	CODE DESCRIPTION
UPPER EXTREMITIES (continued)		
36	36A	The Loss of an Index Finger and Metacarpal Bone*
36	36B	The Loss of an Index Finger at the Proximal Joint*
36	36C	The Loss of an Index Finger at the Second Joint*
36	36D	The Loss of an Index Finger at the Distal Joint*
36	36E	The Loss of a Second Finger and the Metacarpal Bone*
36	36F	The Loss of a Middle Finger at the Proximal Joint*
36	36G	The Loss of a Middle Finger at the Second Joint*
36	36H	The Loss of a Middle Finger at the Distal Joint*
36	36I	The Loss of a Third (Ring) Finger and Metacarpal Bone*
36	36J	The Loss of a Third (Ring) Finger at the Proximal Joint*
36	36K	The Loss of a Third (Ring) Finger at the Second Joint*
36	36L	The Loss of a Third (Ring) Finger at the Distal Joint*
36	36M	The Loss of a Little Finger and Metacarpal Bone*
36	36N	The Loss of a Little Finger at the Proximal Joint*
36	36O	The Loss of a little Finger at the Second Joint*
36	36P	The Loss of a Little Finger at the Distal Joint*
37	37	Thumb*
37	37A	The Loss of a Thumb and Metacarpal Bone*
37	37B	The Loss of a Thumb at the Proximal Joint*
37	37C	The Loss of a Thumb at the Distal Joint*
38	38	Shoulder(s)*
39	39	Wrist(s) & Hand(s)*
TRUNK		
40	40	Multiple Trunk
41	41	Upper Back Area (Thoracic Area)
42	42	Lower Back Area (including Lumbar & Lumbo-Sacral)
43	43	Disc
44	44	Chest (including Ribs, Sternum & Soft Tissue)
45	45	Sacrum and Coccyx
46	46	Pelvis
47	47	Spinal Cord
48	48	Internal Organs
49	49	Heart
60	60	Lungs
61	61	Abdomen Including Groin
62	62	Buttocks
63	63	Lumbar and/or Sacral Vertebrae (Vertebrae NOC Trunk)

* These bilateral body part codes can be reported twice under DN83, when applicable.

Part of Body Codes: FROI (DN36) and SROI (DN83) - Continued		
FROI CODE (DN36)	SROI CODE (DN83)	CODE DESCRIPTION
LOWER EXTREMITIES		
50	50	Multiple Lower Extremities
51	51	Hip*
52	52	Upper Leg*
53	53	Knee*
54	54	Lower Leg*
55	55	Ankle*
56	56	Foot*
57	57	Toe(s)*
57	57A	Little Toe Metatarsal Bone*
57	57B	Little Toe at Distal Joint*
57	57C	The Loss of any other Toe with Metatarsal Bone *
57	57D	The Loss of any other Toe at the Proximal Joint*
57	57E	Other Toe at Middle Joint*
57	57F	The Loss of any other Toe at Second or Distal Joint*
57	57G	Other Toe at Distal Joint*
58	58	Great Toe*
58	58A	The Loss of a Great Toe with Metatarsal Bone*
58	58B	The Loss of a Great Toe at the Proximal Joint*
58	58C	The Loss of a Great Toe at the Second (Distal) Joint *
MULTIPLE BODY PARTS		
64	64	Artificial Appliance
65	65	Insufficient Info to Properly Identify-Unclassified
66	66	No Physical Injury
90	90	Multiple Body Parts
91	91	Body Systems and Multiple Body Systems
99	99	Whole Body

* These bilateral body part codes can be reported twice under DN83, when applicable.

Source: IAIABC/NCCI/WCIO

<https://www.wcio.org/default.aspx>

Cause of Injury Codes (DN37)

CODE	DESCRIPTION
BURN OR SCALD-HEAT OR COLD EXPOSURE	
01	Chemicals
02	Hot Objects or Substances
11	Cold Objects or Substances
03	Temperature Extremes
04	Fire or Flame
05	Steam or Hot Fluids
06	Dust, Gases, Fumes or Vapors
07	Welding Operations
08	Radiation
14	Abnormal Air Pressure
84	Electrical Current
09	Contact With, NOC
CAUGHT IN OR BETWEEN	
10	Machine or Machinery
12	Object Handled
20	Collapsing Materials (Slides of Earth)
13	Caught in, Under or Between, NOC
CUT, PUNCTURE, SCRAPE INJURED BY	
15	Broken Glass
16	Hand Tool, Utensil; Not Powered
17	Object Being Lifted or Handled
18	Powered Hand Tool, Appliance
19	Cut, Puncture, Scrape, NOC
FALL OR SLIP INJURY	
25	From Different Level (Elevation)
26	From Ladder or Scaffolding
27	From Liquid or Grease Spills
28	Into Openings
29	On Same Level
30	Slipped, Did Not Fall
32	On Ice or Snow
33	On Stairs
31	Fall, Slip, Trip, NOC
MOTOR VEHICLE	
40	Crash of Water Vehicle
41	Crash of Rail Vehicle
45	Collision or Sideswipe with Another Vehicle
46	Collision with a Fixed Object
47	Crash of Airplane
48	Vehicle Upset

Cause of Injury Codes (DN37) - Continued	
CODE	DESCRIPTION
MOTOR VEHICLE continued	
50	Motor Vehicle, NOC
STRAIN OR INJURY BY	
52	Continual Noise
53	Twisting
54	Jumping
55	Holding or Carrying
56	Lifting
57	Pushing or Pulling
58	Reaching
59	Using Tool or Machinery
60	Strain or Injury by, NOC
61	Wielding or Throwing
97	Repetitive Motion – Carpal Tunnel Syndrome
STRIKING AGAINST OR STEPPING ON	
65	Moving Parts of Machine
66	Object Being Lifted or Handled
67	Sanding, Scraping, Cleaning Operations
68	Stationary Object
69	Stepping on Sharp Object
70	Striking Against or Stepping on, NOC
STRUCK OR INJURED BY	
74	Fellow Worker, Patient, or Other Person
75	Falling or Flying Object
76	Hand Tool or Machine in Use
77	Motor Vehicle
78	Moving Parts of Machine
79	Object Being Lifted or Handled
80	Object Handled by Others
81	Struck or Injured, NOC (Includes Kicked, Stabbed, Bit, and Etc.)
85	Animal or Insect
86	Explosion or Flare Back
RUBBED OR ABRADED BY	
94	Repetitive Motion
95	Rubbed or Abraded, NOC
MISCELLANEOUS CAUSES	
82	Absorption, Ingestion, or Inhalation, NOC
87	Foreign Matter (Body) in Eye(s)
88	Natural Disasters (Earthquake, Hurricane, Tornado, and Etc.)
89	Person in Act of a Crime (Robbery or Criminal Assault)
90	Other Than Physical Cause of Injury
Cause of Injury Codes (DN37) - Continued	

November 15, 2011 (DATE TO BE INSERTED BY OAL – 6.12 MONTHS FOLLOWING APPROVAL AND FILING WITH SECRETARY OF STATE)

CODE	DESCRIPTION
MISCELLANEOUS CAUSES -- continued	
91	Mold
96	Terrorism
98	Cumulative, NOC
99	Other-Miscellaneous, NOC

Source: IAIABC/NCCI/WCIO

<https://www.wcio.org/default.aspx>

Late Reason Codes (DN77)

Codes	Description
Delays	
L1	No excuse
L2	Late Notification, Employer
L3	Late Notification, Employee
L4	Late Notification, State
L5	Late Notification, Health Care Provider
L6	Late Notification, Assigned Risk
L7	Late Investigation
L8	Technical Processing Delay/Computer Failure
L9	Manual Processing Delay
LA	Intermittent Lost Time Prior to First Payment
Coverage	
C1	Coverage Lack of Information
Errors	
E1	Wrongful Determination of No Coverage
E2	Errors from Employer
E3	Errors from Employee
E4	Errors from State
E5	Errors from Health Care Provider
E6	Errors from Other Claim Administrator/IA/TPA
Disputes	
D1	Dispute Concerning Coverage
D2	Dispute Concerning Compensability in Whole
D3	Dispute Concerning Compensability in Part
D4	Dispute Concerning Disability in Whole
D5	Dispute Concerning Disability in Part
D6	Dispute Concerning Impairment

Source: IAIABC, ANSI A9

Class Codes (DN59)

Class codes (DN59) are required for insured employers and are optional for self-insured employers. These are California-specific codes from the Workers’ Compensation Insurance Rating Bureau (WCIRB) of California. The WCIRB updates these codes annually in January. They are available on the WCIRB website:

https://wcirbonline.org/wcirb/Answer_center/classification_information.html. The National Council on Compensation Insurance (NCCI) class codes are not accepted.

All California businesses are classified using the Standard Classification System found in Part 3 of the WCIRB’s *Uniform Statistical Reporting Plan*, which is part of the California Code of Regulations and is approved by the Insurance Commissioner. The Standard Classification System, which contains approximately 500 industry classifications, describes groups of employers whose businesses are relatively similar. Each classification reflects the type of operations common to that group of employers.

Changes to class codes from the previous year’s codes are listed in Memorandum 1 of the *Uniform Statistical Reporting Plan*, which is found online at https://wcirbonline.org/wcirb/root/pdf/usrp_ic_regs_only.pdf. These changes are published as of January 1 of each year.

All class codes should be submitted to the WCIS using a four-digit alpha-numeric format. The WCIS does not require trading partners to report information on subdivisions of class codes below the four-digit level, such as

- 0038 (1) stock farms, and
- 0038 (2) feed yards.

In this example, only 0038 would need to be reported. Zeros are padded to the left, as the following examples show:

CLASS CODE	DESCRIPTION
0005	Nurseries--propagation and cultivation of nursery stock
0016	Orchards -- citrus and deciduous fruit
0034	Farms--poultry raising
0035	Florists--cultivating or gardening
0036	Farms--dairy farms
0038	Farms--stock farms and feed yards
0040	Farms--vineyards

Payment/Adjustment and Paid to Date (DN85 and DN95) Benefit Type Codes

Settlements are reported using compromised payment benefit type codes 5xx. Examples of settlement types are compromise and release, findings and award, findings and order, and stipulated settlements. See Section M—System Specifications for more details on reporting settlements.

Payment/Adjustment (DN85) Benefit Type Codes Used in the WCIS			
BTC	Code Description	BTC	Compromised Payment Code Description
		500	Unspecified
		501	Medical
010	Fatal	510	Fatal
020	Permanent Total	520	Compromised Permanent Total
030	Permanent Partial Scheduled	530	Compromised Permanent Partial Scheduled
050	Temporary Total	550	Compromised Temporary Total
070	Temporary Partial	570	Compromised Temporary Partial
090	Permanent Partial Disfigurement	590	Compromised Permanent Partial Disfigurement
240	Employer Paid	524	Compromised Employer Paid

Payment/Adjustment (DN85) Benefit Type Codes that, in most cases, should NOT be sent to the WCIS on recent claims:			
BTC	Code Description	BTC	Compromised Payment Code Description
021	Permanent Total Supplemental	521	Compromised Permanent Total Supplemental
051	Temporary Total Catastrophic	551	Compromised Temporary Total Catastrophic
080	Employer Liability	580	Compromised Employer Liability
040	Permanent Partial Unscheduled	540	Compromised Permanent Partial Unscheduled
410	Vocational Rehabilitation Maintenance	541	Compromised Vocational Rehabilitation Maintenance

Notes: For injuries that were permanent and stationary on or after 1/1/2005, PD payments have been scheduled using the 2005 Permanent Disability Rating Schedule, so unscheduled payment codes (040, 540) should not be sent. As of 1/1/2009, the vocational rehabilitation program was ended, so codes 410 and 541 are no longer applicable. Payments for the California Supplemental Job Displacement Benefit (SJDB) Program should be sent under DN95, BTC 390.

Paid to Date/Reduced Earnings/Recoveries (DN95) Benefit Type Codes Used in the WCIS			
BTC	Code Description	BTC	Code Description
300	Funeral Expenses PTD	430	Unallocated Prior Indemnity Benefits PTD
310	Penalties PTD	440	Unallocated Prior Medical PTD
320	Interest PTD	450	Pharmaceutical PTD
330	Employer's Legal Expense PTD	460	Physical Therapy PTD
340	Claimant's Legal Expense PTD	600-624	Actual Reduced Earnings
350	Total Payments to Physician PTD	650-674	Deemed Reduced Earnings
360	Hospital Costs PTD	800	Special Fund Recovery
370	Other Medical PTD	810	Deductibles Recovery
380	Vocational Rehabilitation Evaluation PTD	820	Subrogation Recovery
390	Vocational Rehabilitation Education PTD or Supplemental Job Displacement Benefit (SJDB) PTD	830	Overpayment Recovery
400	Other Vocational Rehabilitation PTD	840	Unspecified Recovery
420	Expert Witness Fees PTD		

Payments for the California Supplemental Job Displacement Benefit (SJDB) Program should be sent under DN95, BTC 390

November 15, 2011 (DATE TO BE INSERTED BY OAL – 6-12 MONTHS FOLLOWING APPROVAL AND FILING WITH SECRETARY OF STATE)

Industry Codes (DN25)

The industry code should represent the primary nature of the employer's business. If the employer is assigned multiple industry codes, use the code that relates to the specific business operation for which the employee was employed at the time of injury. For claims with dates of injury on or after the implementation date of this guide, only the North American Industry Classification System (NAICS) codes are accepted. For claims with a date of injury prior to the implementation date of this guide, both Standard Industrial Classification (SIC) and North American Industry Classification System (NAICS) codes are accepted by WCIS, but NAICS codes are preferred.

Per the IAIABC Release 1 specifications, the industry code (DN25) must be sent as a six-digit alpha-numeric code. According to WCIS data edits, the industry code (DN25) is a Mandatory/Serious data element.

A list of valid industry codes can be found at the U.S. Census Bureau Website <http://www.census.gov/epcd/www/naics.html>. ~~SIC codes were last updated in 1987.~~ NAICS codes are updated every five years by the Census Bureau, for example: 1997, 2002, 2007 and 2012.

The DWC encourages trading partners to submit the most recent six-digit North American Industry Classification System (NAICS) codes to the WCIS. For example, for Soy Bean Farming, the ~~2007~~2012 six-digit NAICS code is 111110. If the trading partner does not know the industry to the detailed six-digit level, but can submit the industry code at a higher level of aggregation, then the 2-digit, 3-digit or 4-digit NAICS code should be submitted to the WCIS in alpha-numeric format with zeros padded to the right. Using ~~2007~~2012 NAICS codes as an example:

	NAICS	
6-digit code	111110	Soy Bean Farming
4-digit	111100	Oilseed and Grain Farming
3-digit	111000	Crop Production
2-digit	110000	Agriculture, Forestry, Fishing and Hunting

If 1987 Standard Industrial Classification (SIC) codes are submitted, the four-digit SIC code needs to be joined with the letters "SC" in the last two positions. Four-digit codes without the "SC" suffix will be accepted with error, as there is no way to differentiate between a four-digit SIC and a four-digit NAICS code. For example, for the SIC code "0116 - Soybeans", the trading partner would submit "0116SC" to the WCIS. Note that for SIC codes, the zeros are padded to the left.

Section O: EDI Terminology

Abbreviations and Acronyms

Acronyms and Abbreviations	Definition
AK1	A flat file type used for sending detailed acknowledgments
ANSI	American National Standards Institute
DIR	Department of Industrial Relations
BAIS	Basic Administrative Information System
DLSR	Division of Labor Statistics and Research
DOB	Date of Birth
DOI	Date of Injury
DN	Data Number – Identification number assigned to each data element in an IAIABC transaction
DWC	Division of Workers' Compensation
EDI	Electronic Data Interchange
E-mail	Electronic mail
FEIN	Federal Employer Identification Number
FROI	First Report of Injury
FTP	File Transfer Protocol
FTPS	File Transfer Protocol over SSL
IAIABC	International Association of Industrial Accident Boards and Commissions
ICD9	International Classification of Diseases 9 th Revision
IP	Internet Protocol
ISP	Internet Service Provider
JCN	Jurisdiction Claim Number (DN5)
NAICS	North American Industry Classification System
MTC	Maintenance Type Code (DN2)
PGP	Pretty Good Privacy
SFTP	SSH File Transfer Protocol
SIC	Standard Industrial Classification
S/MIME	Secure/Multipurpose Internet Mail Extensions
SROI	Subsequent Report of Injury
SSH	Secure Sockets Layer Shell
TA	Transaction Accepted (without errors)
TE	Transaction Accepted with Errors
TPA	Third Party Administrator
TP	Trading Partner
TR	Transaction Rejected
URL	Uniform Resource Locator
VAN	Value-Added Network
WCAB	Workers' Compensation Appeals Board
WCIRB	Workers' Compensation Insurance Rating Bureau of CA
WCIS	Workers' Compensation Information System

EDI Glossary

Acknowledgment	A file sent from WCIS to a trading partner in order to provide feedback on a first or subsequent report batch from that trading partner. This file indicates whether each transaction was accepted, accepted with errors, or rejected. Applicable error codes are provided for each data element.
Agency Claim Number	Release 1 flat-file name for Jurisdiction Claim Number (JCN), DN5. This claim identifier is generated by WCIS at the time a claim record is first created. It must be provided on most transactions throughout the life of the claim.
ANSI X12	An EDI file format in which data elements are strung together continuously, with special data-element identifiers and separator characters delineating individual data elements and records.
Batch	A group of EDI records in ANSI or IAIABC flat format. Each batch consists of a header record, one or more transaction records containing claim data, and a trailer record.
Benefit Event	An event that triggers a report. Example: Benefits are starting and a first payment is made – an IP Report would be sent.
Benefit Period	an uninterrupted period of benefit payments for a particular benefit code.
Claim Administrator	A self-administered insurer, third party administrator, or self-insured, self-administered employer legally responsible for proper handling of a workers' compensation claims.
Data Element	A piece of information to be included in an EDI file. Examples include date of injury, last name, or Maintenance Type Code (MTC). An IAIABC flat-file data element can also be referenced by its "data number" (DN). For example, the Maintenance Type Code is also referred to as "DN2".
Digital Certificate	Files issued by a certified security authority (such as VeriSign, Inc.), used to verify signatures on digitally signed mail and to send encrypted e-mail. Once the sender and receiver have exchanged valid digital certificates, all e-mail between them can be encrypted automatically.
File Format	The manner in which data elements are organized in a file. The two file formats accepted by WCIS are the IAIABC flat file and the ANSI X12 format.

Flat File	An EDI file format in which data elements are placed in assigned positions within each record. Different records are presented on separate lines of the EDI file. Proprietary flat file standards for use in workers' compensation have been developed by the IAIABC.
First Report of Injury (FROI)	A class of EDI transactions that include the same data provided on the paper First Report of Injury or Illness (California Form 5020).
Jurisdiction Claim Number (JCN)	This claim identifier is generated by WCIS at the time a claim record is first created in the database. It is data element DN5 in the flat-file format. The JCN must be provided on most transactions throughout the life of the claim. In Release 1, this data element is called "Agency Claim Number."
Header Record	The first record in a formatted EDI file, which identifies the sender, receiver, and file format version used. The header and trailer records combine to create an "envelope" surrounding a batch of transactions.
IAIABC	The International Association of Industrial Accident Boards and Commissions, an organization that develops Electronic Data Interchange standards for use in workers' compensation.
Maintenance Type Code (MTC)	The IAIABC flat-file data element that identifies the business objective of a given EDI transaction. (ANSI equivalent is Purpose Code.)
Parallel Phase	The period during which a trading partner's EDI data is cross-analyzed with hard copies.
Pilot Phase	The period during which a trading partner is demonstrating their ability to send data via EDI that is "complete, valid, and accurate" (see WCIS regulations). This stage begins when the trading partner has passed the test stage, and ends when the trading partner has been approved for <u>Parallel Production</u> status.
Policy Year	The same policy year as the one reported to the WCIRB (Workers' Compensation Insurance Rating Bureau of California).

Production Phase	The period that begins when a trading partner has demonstrated the ability to send complete, valid, and accurate data for a given class of reports via EDI. This follows successful completion of the test and pilot phases. Claims administrators granted production status for First Reports are no longer required to send paper Employer's Reports (Form 5020) to DLSR. Claims administrators granted production status for Subsequent Reports satisfy the requirement to submit paper Benefit Notices to the Division.
Purpose Code	The ANSI data element that identifies the business objective of a given EDI transaction. (IAIABC flat-file equivalent is <i>Maintenance Type Code, MTC</i> .)
Receiver	The trading partner receiving EDI transmissions.
Release 1	A set of workers' compensation EDI data specifications released by the IAIABC in August, 1995.
Report	Often used synonymously with "transaction".
Sender	The trading partner sending EDI transmissions.
Subsequent Report of Injury (SROI)	A class of EDI transactions that include the types of data provided on California benefit notices. WCIS regulations stipulate when these transactions are required. For example, SROI are to be provided whenever indemnity benefit payments are begun or terminated.
Test Phase	The phase in which a trading partner sends test batches in order to ascertain whether WCIS can read their EDI files. At this phase, WCIS checks the header and trailer record and confirms basic record formats, but does not perform validations on individual data elements. Once this test phase is successfully completed, the trading partner advances to the pilot phase.
Trading Partner	One of the parties exchanging EDI transmissions, either the state jurisdiction, the "claims administrator" (insurer, self-insured employer, or third party administrator), or a collection of claims administrators. Each trading partner providing data to WCIS is expected to complete a Trading Partner Profile form. One such form can cover multiple Claim Administrators whose data will be combined in transactions and which will be considered together for testing, piloting, and data-quality reports. For example, a parent organization with multiple subsidiary claim administrator organizations

may wish to combine all its data into transmissions sent from a central office.

- Trailer Record The last record in a formatted EDI file, which indicates a count of transactions contained within the batch. The header and trailer records combine to create an “envelope” surrounding a batch of transactions.
- Transaction A section of a batch file representing a single first report of injury or a single benefit notice for an individual claim.
- Transmission A file in ANSI or IAIABC flat format containing one or more batches of transactions.

DRAFT

Appendix A: Revised WCIS System Updates

Clarification of Issues:

1. The Payment/Adjustment Paid to Date (DN86) refers to the cumulative paid-to-date amount of the benefit over the life of the claim, including any and all previous calendar years.
2. The revised version of WCIS will continue to accept multiple MTCs for the same claim in the same batch file.
3. MTC DATE: For most transactions, the IAIABC defines the MTC date as the date the “transaction was moved to the transmission queue or flagged for transmission”, except for the following MTCs:
 - a. CO – MTC date of the Original Transaction being corrected that contained non-critical error(s).
 - b. AP – Issue date of a check sent as the initial indemnity benefit payment after acquiring the claim.
 - c. CA – Date the change in Payment/Adjustment amount was effective.
 - d. IP – Issue date of check sent as the initial indemnity benefit payment.
 - e. P1 through PJ – The last date through which indemnity benefits are due.
 - f. PY – Issue date of payment.
 - g. RB – Issue date of the check reinstating indemnity benefits.
 - h. S1 through SJ – The last date through which indemnity benefits are due.
4. Some Payment/Adjustment Codes (DN85) should not be sent to the WCIS on recent claims. Examples are Temporary Total Catastrophic (051) and (551) as well as Employers’ Liability (080) and (580); As of 1/1/2005, Partial Unscheduled (040) and (540); As of 1/1/2009, Vocational Rehabilitation Maintenance (410) and (541).

Differences Between Version 3.0 and Version 3.1 of WCIS FROI/SROI

1. For claims with date of injury after the implementation date of this guide, the Standard Industrial Classification (SIC) codes will not be accepted as valid Industry Codes (DN25) Only North American Industry Classification System (NAICS) codes will be accepted.
2. The only transmission mode allowed will be via SFTP also known as SSH (Secure Shell) File Transfer Protocol.
3. The suffix for the user name of the FTP account will be “@WCIS FS”.
4. Third Party Administrator FEIN (DN 8) has been renamed Claim Administrator FEIN (DN 8) and Third Party Administrator Name (DN 9) has been renamed Claim Administrator Name (DN 9). Claim Administrator FEIN (DN 8) is now Mandatory/Fatal on all FROI transactions. Claim Administrator Name (DN 9) is now Mandatory/Serious on FROI 00, AU, 04, 02, and CO. Claim Administrator Name (DN 9) is now Optional on the FROI 01.
5. Agency Claim Number/Jurisdiction Claim Number (DN 5), Insurer FEIN (DN 6), Claim Administrator FEIN (DN 8), Claim Administrator Claim Number (DN 15), Date of Injury (DN 31), Employee Date of Birth (DN 52), the first two characters of Employee First Name (DN 44), Employer FEIN (EMP FEIN) (DN 16), and Time of Injury (DN 32) are now used in the claim matching process.
6. Agency Claim Number/Jurisdiction Claim Number (DN5) is now required on all transactions except for the FROI 00, 04 and AU.
7. Claim Administrator Claim Number (DN15) is now Mandatory/Fatal on a FROI Cancel (MTC=01).
8. Claim Administrator Claim Number (DN15) is now Mandatory/Fatal on all SROI.
9. Date of Injury (DN 31) is now Mandatory/Fatal on all SROI.
10. Industry Code (DN 25) is now Optional on a FROI Cancel (MTC=01).
11. Nature of Injury Code (DN 35) is now Mandatory/Serious on a FROI Acquired/Unallocated (MTC=AU).
12. Part of Body Injured Code (DN 36) is now Mandatory/Serious on a FROI Acquired/Unallocated (MTC=AU).
13. The Employee Date of Death (DN57) is now Conditional/Serious on the SROI IP, AP, FS, 4P, 04, CA, CB, RE, RB, PY, AN, FN and UR.
14. The Permanent Impairment Body Part Code (DN83) is now only required on the SROI Final (MTC=FN) and the SROI Upon Request (MTC=UR).

15. The SROI Date Disability Began (SROI DN56) is now defined by DWC as the first date of lost time for the current benefit period. The FROI Date Disability Began (FROI DN56) remains the original date of lost time.
16. The Nature of Injury (DN 35), Part of Body (DN36), and Cause of Injury (DN 37) code lists have been removed and links to the source are now provided.
17. The Time of Injury (DN 32) and ~~Initial Treatment (DN39)~~ are now Conditional/Serious on the FROI 00, ~~AU~~, 04, 02 and CO.
18. The Date of Maximum Medical Improvement (DN70) is Mandatory on the SROI FN and UR when reporting ~~and-closing~~ permanent disability benefits (DN85=020, 021, 030, 040, or 090 and the Date of Injury (DN 31) is > 1/1/2013. The Date of Maximum Medical Improvement (DN70) is Mandatory on the SROI FN and UR when reporting ~~and-closing~~ permanent disability benefits (DN85=020, 021, 030, 040, or 090 and the Date of Injury (DN 31) is < 1/1/2013 and the MMI date is known.
19. The Claim Status (DN 73) is now Mandatory/Fatal on the SROI FN and AN. The Claim Status (DN73) must = C or X on the SROI FN.
20. The Claim Type (DN 74) is now Mandatory/Fatal on all SROIs except the CD, 02, and CO.
21. The Payment/Adjustment Start Date (DN 88) and the Payment/Adjustment End Date are now mandatory based on the Date of Injury (DN 31) being > than 6/18/2012.
22. The requirement for submission of the FROI and SROI Correction (MTC=CO) is now within ~~30~~ 60 calendar days of original TE acknowledgment.
23. Class Code (DN 59) is now optional on FROI ~~04~~, Denial (MTC=04), and Conditional /Serious on FROI Original (MTC=00), Acquired (MTC=AU), and Change/Correction (02, CO).
24. For indemnity claims, the SROI AN and FN must be preceded by a, ~~FROI~~ ~~AU~~ SROI IP, AP, CD, FS, PY or UR, as applicable.
25. The edit for error 035 (must be >= Date Disability Began) has been removed for DN 88 and 89 (Payment/Adjustment Start and End Date).
26. For SROI Date Disability Began (DN 56), if Nature of Injury Code (DN 35) is not between 60 and 80, then DOI (DN 31) ~~<~~ ≤ DDB (DN 56) is Mandatory.
27. Payment/Adjustment Code (DN 85) and Payment/Adjustment Paid to Date (DN 86) are now Mandatory/Fatal on SROI Payment (MTC=PY).

Payment/Adjustment Code (DN 85) is now Conditional/Fatal on SROI Final (MTC=FN) and Annual (MTC=AN).

~~28. Date of Injury (DN 31) is now Mandatory/Fatal on FROI Cancel (MTC=01).~~

29. Employee Date of Birth (DN 52) is now Mandatory/Fatal on FROI Original (MTC= 00), ~~Cancel (MTC=01)~~, Denial (MTC=04), Change (MTC=02), and Correction (MTC=00). Employee Date of Birth (DN 52) is now Conditional/Fatal on FROI Acquired/Unallocated (MTC=AU).

~~30. Wage (DN 62) and Wage Period (DN 63) are now Mandatory/Serious on FROI Original (MTC= 00), Acquired/Unallocated (MTC=AU), Denial (MTC=04), Change (MTC=02), and Correction (MTC=00).~~ Wage Period (DN 63) is now Mandatory/Serious on SROI Initial Payment (MTC=IP), Acquired Payment (MTC=AP), Change in Amount (MTC=CA), Change in Benefit (MTC = CB), Change (MTC=02), Correction (MTC=00), and Upon Request (UR).

31. The parallel EDI process has been removed.

32. The requirement that the SROI Change and Correction (MTC=02 and CO) transactions must have at least one previous benefit event has been removed for SROI 02 and CO transactions where the Claim Status (DN 73) or Date of Representation (DN 76) is present.

33. SROI (MTCs=CA, Px and Sx) must be preceded by a least one previous benefit event of any Payment/Adjustment Code (DN 85).

34. The requirement that Date of Return/Release to Work (DN 72) be greater than or equal to Date of Return to Work (DN 68) has been removed.

35. The fax number in WCIS EDI contacts and the Trading Partner Profile Part D. Receiver Information has been removed.

36. The file naming convention for FROI and SROI files has been updated. Only files that follow the new file naming convention will be accepted.

37. The Policy Number (DN 28), Policy Effective Date (DN 29), and Policy Expiration Date (DN 30) are now Optional on the FROI Acquired (MTC=AU) and FROI Denial (MTC = 04).

38. The requirement that Date of Return to Work (DN 68) must be greater than Date Disability Began (DN 56) has been removed.

39. The requirement that Date of Maximum Medical Improvement (DN 70) must be greater than Date Disability Began (DN 56) has been removed.

Differences Between Version 2.1 and Version 3.0 of WCIS:

1. The Receiver zip code for the WCIS is now 94612-1489.
2. The FROI Original (MTC=00) reporting due date is now within 10 business days of claim administrator knowledge of the claim.
3. For the Social Security Number (DN42) and Employer FEIN (DN16), a default value of "000000006" will be accepted if the employee has no SSN/FEIN or refuses to provide it.
4. On any transaction, the Insurer FEIN (DN6), Third Party Administrator FEIN (DN8), if any, and Claim Administrator Postal Code (DN14) must match what was reported on the Insurer/Claim Administrator ID list for the Sender or the transaction will be rejected.
5. The allowed methods of transmitting data from claim administrators to WCIS are:
 - File Transfer Protocol (FTP) over SSL (Secure Sockets Layer), also known as FTPS, or
 - FTPS with PGP (Pretty Good Privacy) encryption.
6. The Policy Number (DN28), Policy Effective Date (DN29), and Policy Expiration Date (DN30) have been added to the FROI data requirement table. They are Conditional/Serious on the FROI 00, 02, 04, AU and CO.
7. The Payment/Adjustment Weekly Amount, Weeks and Days Paid (DN87, 90 and 91) are Mandatory/Fatal on the SROI IP, AP, FS, CA, CB, RE, Px, Sx, and RB, Conditional/Fatal on the SROI 02, CO, 4P, AN, FN, and UR, and Optional on the SROI CD, 04 and PY.
8. The Third Party Administrator FEIN (DN8) is now a Conditional/Fatal data element on the FROI and SROI.
9. The Third Party Administrator Name (DN9) is now a Conditional/Serious data element on the FROI.
10. The FROI Original (MTC=00) will not be accepted when sent with an Agency/Jurisdiction Claim Number (DN5).
11. The Payment/Adjustment Paid To Date (DN86), when required, must be greater than or equal to zero.
12. The Payment/Adjustment Start Date and Payment/Adjustment End Date (DN88 and 89), when required, must be a valid date.
13. The Paid To Date/Reduced Earnings/Recoveries Amount (DN96), when required, must be greater than or equal to zero.

14. The Benefit Adjustment Weekly Amount (DN93), when required, must be greater than or equal to zero.
15. The Benefit/Adjustment Start Date (DN94), when required, must be a valid date.
16. The Date of Maximum Medical Improvement (DN70) is now only required on the SROI Final (MTC=FN) and the SROI Upon Request (MTC=UR).
17. The SROI Annual (MTC=AN) and SROI Final (MTC=FN) will now be accepted if a previously reported indemnity benefit is missing in the AN or FN.
18. The SROI Annual (MTC=AN) and SROI Final (MTC=FN) will now be accepted if a previously unreported indemnity benefit is reported in the AN or FN.
19. Any existing indemnity benefits will automatically be suspended when the FROI Acquired Unallocated (MTC=AU) is accepted.
20. The Secondary Match Logic for transactions other than the FROI Original (MTC=00) and Acquired/Unallocated (MTC=AU) that are sent without an Agency/Jurisdiction Claim Number (DN5) is now based on the Insurer FEIN (DN6) AND the Third Party Administrator FEIN (DN8), if any, AND the Claim Administrator Claim Number (DN15).
21. The Class Code (DN59) table has been deleted from this Guide. Trading partners are referred to the WCIRB class code table available online.
22. The Class Code (DN59) must be a valid WCIRB class code when sent.
23. The NAICS code (DN25) table has been updated for 2007 codes.
24. The FN can and should be sent in when a claim is closed, even if no benefits have been paid.
25. The Payment/Adjustment Codes 040, 051, 080, 540, 551 and 580 should not be sent.
26. The parallel phase in Section G-Test, Pilot, Parallel and Production Phases of EDI is now optional.
27. The sequencing edits "Closes must follow opens for the same BTC" and "Update (open) must follow opens for the same BTC" have been removed.
28. The Industry Code (DN25) is now a Mandatory/Serious data element.
29. The Permanent Impairment Percent (DN84) is now only required on the SROI Final (MTC=FN) and the SROI Upon Request (MTC=UR).
30. The edits for error 035, must be >= Date Disability Began, on the Start Date (DN88) and the End Date (DN89) have been removed.

Differences Between Version 2.0 and Version 2.1 of WCIS:

1. The **Jurisdiction Claim Number** or **JCN** (DN05) has been increased from 12 digits to **22 digits**. The IAIABC rules allow a JCN of 25 characters.
2. The new system will continue to process all older claims submitted and processed prior to the switchover with the original 12 digit JCNs.
3. **Future Payment/Adjustment Start and End Dates** (DN88 and DN89) will be accepted. The edit for error message #37, "Must be <= MTC Date", has been removed for DN88 and DN89.
4. **FROI Cancel** (MTC=01) will be accepted after a SROI transaction has been accepted. This process cancels the entire claim, including all FROI and SROI transactions. Even though the IAIABC Release 1 format has no SROI Cancel, this will perform that function. In addition, a 01 Cancel will be able to follow a 04 Denial, as documented in the EDI Guide.
5. **The Release 2 transaction format will no longer be accepted.**
6. **MTC dates** (DN3) must be <= current system date.
7. **IP**: Only one "IP" transaction is allowed for each claim. Since a new benefit can be opened with a "CB" transaction, there is no need to report more than one "IP".
8. **Error Messages**: The February 15, 2002 revised edition of the IAIABC Edit Matrix (<http://www.iaiaabc.org>) error messages (Section 3) has been incorporated in the revised WCIS system.
9. **M/S**: The following Mandatory/Serious (M/S) data elements, if sent with an invalid or blank USPS Postal Code or an invalid or blank date will result in a "TE" acknowledgment.
 - a. DN23-Employer Postal Code
 - b. DN33-Postal Code of Injury Site
 - c. DN41-Date Reported to Claim Administrator
 - d. DN72-Date of Return/Release to Work (Note: for MTC=RE only)
10. **M/F**: DN14-Claim Administrator Postal Code is now a Mandatory/Fatal (M/F) data element; an invalid or blank USPS Postal Code will result in a "TR" acknowledgment.
11. **C/S**: The following Conditional/Serious (C/S) data element, if sent with an invalid or blank date, will result in a TE acknowledgment.

DN72-Current Return to Work Date (Note: For MTCs = S1 or P1 only).
12. **CD**: The MTC "Compensatory Death" (CD) will automatically close all open BENs.

13. **RB:** A suspension type MTC, such as S1 or P1, or an equivalent MTC, such as UR or CB, must precede an RB, which can open a new benefit or reopen an old one. An RB following an IP will no longer be accepted. This is consistent with the IAIABC Guide.
14. **AN/FN:** Must report all previously reported indemnity and non-indemnity benefits. If any of these benefits are missing, the transaction will be rejected. The AN/FN cannot report any new indemnity benefits but can report new non-indemnity benefits. On FN, all previously reported indemnity benefits must be suspended first. *

An AN cannot be used to close claims with indemnity benefits. The proper transaction is an FN, as explained in e-News 7:

<http://www.dir.ca.gov/DWC/WCISenews/WCISen7.htm>

15. **AN/FN/SROI 04:** Must contain some type of indemnity or non-indemnity payment information. **

*This difference has been revised in Version 3.0. See difference #18 in the Differences Between Version 2.1 and Version 3.0 of WCIS

**This difference has been revised in Version 3.0. See difference #24 in the Differences Between Version 2.1 and Version 3.0 of WCIS

Appendix B: Revision History – Summary of Principal Changes from Previous Versions

Version 3.1

Section A: Updated deadline for AN and Minor updates on FTP transmission.

Section B: Added WCIS Training Bulletins section. Removed fax number from WCIS contact person section.

Section D: Deleted statutory language for Labor Code 138.6 and 138.7.

~~Section E: Added WCIS penalty regulation information.~~

Section F: Minor updates. Updated transmission mode information. Removed the Expected Transmission Days of Week section. Removed the substitution of Insurer FEIN (DN6) for submissions that do not provide the Third Party FEIN (DN8). Added the WCIS Reports Contact. Removed fax number from Part D. Receiver Information. Added FTP user account and password to be provided by WCIS.

Section G: Minor updates. Added structural edit for invalid FROI record length and invalid trailer record length. Removed Parallel process. Added WCIS penalty report information. Changed the timeframe for Trading Partners to receive feedback during the testing phase from 48 hours to 3 business days. Added the Audit Unit's Annual Report of Inventory as a check for completeness during the pilot phase. Added language that 95% of all required claims should be submitted accurately and on-time. Added language that 95% of all required transmissions should be free of uncorrected TRs and TEs. Removed language exempting trading partners for unknown claims.

Section I: Minor updates and clarifications. Updated transmission mode information. Added SFTP user account and password to be provided by WCIS. Changed the file naming convention.

Section J: Minor updates to requirements and implementation notes. FROI and SROI COs are due within ~~30~~ 60 calendar days of original TE acknowledgment. The AN must be submitted for every claim with any benefit activity (including medical) during the preceding calendar year, for every open claim with no benefit activity during the preceding calendar year, and for every claim that was closed during the preceding calendar year. Claims identified as having no coverage upon knowledge of the claim need not be submitted to WCIS.

Section K: Updated requirements for Agency Claim Number (DN 5), Claim Administrator FEIN (DN 8), Claim Administrator Name (DN 9), Claim

Administrator Claim Number (DN 15), Industry Code (DN 25), Policy Number (DN 28), Policy Effective Date (DN 29), Policy Expiration Date (DN 30), Date of Injury (DN 31), Time of Injury (DN 32), Nature of Injury Code (DN 35), Part of Body Injured Code (DN 36), Employee Date of Birth (DN 52), Class Code (DN 59), Employee Date of Death (DN 57), ~~Wage (DN 62), Wage Period (DN 63),~~ Claim Status (DN 73), Claim Type (DN 74), Permanent Impairment Body Part Code (DN 83), Payment/Adjustment Code (DN 85), and Payment/Adjustment Paid to Date (DN 86). Updated conditional rules and implementation notes for Agency Claim Number (DN 5), Claim Administrator FEIN (DN 8), Claim Administrator Name (DN 9), Claim Administrator Claim Number (DN 15), Employer FEIN (DN 16), Policy Number (DN 28), Policy Effective Date (DN 29), Policy Expiration Date (DN 30), Nature of Injury Code (DN 35), Part of Body Injured Code (DN 36), Employee Date of Birth (DN 52), Date Disability Began (DN 56), Employee Date of Death (DN 57), Wage Period (DN 63), Date of Maximum Medical Improvement (DN 70), Claim Status (DN 73), Claim Type (DN 74), Number of Permanent Impairments (DN 78), Permanent Impairment Body Part Code (DN 83), Payment/Adjustment Code (DN 85), Payment/Adjustment Paid to Date (DN 86), Payment/Adjustment Weekly Amount (DN 87), Payment/Adjustment Start Date (DN 88) and Payment/Adjustment End Date (DN 89), Payment/Adjustment Weeks Paid (DN 90), Payment/Adjustment Days Paid (DN 91), Paid to Date/Reduced Earnings/Recoveries Code (DN 95), Paid to Date/Reduced Earnings/Recoveries Amount (DN 96). Added requirements for Time of Injury (DN 32) and ~~Initial Treatment (DN39)~~. Added definition for FROI and SROI Date Disability Began (DN56).

Section L: Removed FROI and SROI alphabetical data element tables. Minor corrections and updates.

Section M: Minor SROI AN update. Updated matching criteria and processes for the submission of all FROI and SROI transactions. A PY should now be sent to report an advance or settlement that is the first indemnity payment. Previous reported SROI benefits are now required on SROI Change in Amount (CA), SROI Partial Suspensions (Px), and Suspensions (Sx). SROI benefits are no longer required on SROI Changes (02). The requirement that the SROI Change and Correction (MTC=02 and CO) transactions must have at least one previous benefit event has been removed for SROI 02 and CO transactions where the Claim Status (DN 73) or Date of Representation (DN 76) is present. Minor language change regarding the payment of stipulated settlements.

Section N: Updated web links and removed Standard Industrial Classification (SIC) codes as acceptable codes for the Industry Code (DN25). Removed Nature of Injury (DN 35), Part of Body (DN 36 and 83), and Cause of Injury (DN 37) tables.

Section O: Section J: Minor updates and corrections.

Appendix A: Added the SROI Final (FN) to difference #18 and the removal of the Payment/Adjustment Start/End Date vs Date Disability Began edit as difference #30 in Differences Between Version 2.1 and Version 3.0 of WCIS. Added new version 3.1 differences in Differences Between Version 3.0 and Version 3.1 of WCIS.

Version 3.0

Section A: Updated the FROI Original (MTC=00) reporting requirement from 5 to 10 business days. Removed references to VAN and e-mail transmission options.

Section A: Corrected previous error: Subsequent Reports of Injury (SROIs) are submitted within 15 business days...

Section B: EDI Service Provider information in Section B was expanded to include information from the deleted Section J. The listing of EDI Service Providers is now available online.

Section C: Updated references to new Sections (J,K,L,M,N,O,P) and to listing of EDI Service Providers, which is now provided online. Removed references to VAN and e-mail transmission options.

Section F: Updated Part C2 and C3 of the Trading Partner Profile to use a WCIS-hosted FTP as the sole transmission mode. Included ID list in the Trading Partner Profile, E (Form DWC WCIS TP01 Revised 01/08). Added requirement for reporting claim administrator postal codes in ID list. Updated WCIS zip code to 94612-1491.

Section G: Minor updates and corrections. Removed references to VAN and e-mail transmission options. Removed Crosswalk of Employer's (Form 5020), Doctor's (Form 5021), and EDI First Report.

Section I: FTP transmission mode updated. Removed references to VAN and e-mail transmission options.

Section J: Deleted. Information is available online so it can be updated more easily.

Section K: Renamed Section J.

Updated reporting requirement for First Reports of Injury (FROIs) to 10 business days. Corrected previous error: Subsequent Reports of Injury (SROIs) are submitted within 15 business days. Clarified language for Annual (AN) summary and Payment (PY).

Section L: Renamed Section K

Filled in blanks with "optional" in tables

Corrected previous errors:

- DN58 deleted from FROI data requirements.
- Added DN54 to SROI

Changed some data requirements.

Clarified SROI and FROI conditional fields.

Section M: Renamed Section L

Added CA-specific edits for DN5, DN6, DN8 and DN86.

Changed default value on Social Security Number.

Added California-adopted IAIABC Data Elements, sorted various ways.

Section N: Renamed Section M

Clarified 4P, AN and FN reporting.

Removed benefit sequencing rules.

Clarified advances and settlement reporting including the reporting of attorney fees.

Made WCIS secondary matching rules more precise.

Corrected Acquired Claims diagram.

Section O: Renamed Section N

Added web links for code lists and make corrections.

Part of Body Codes: Made table easier to read.

Added note about bilateral body part reporting.

Deleted WCIRB class code list, but added online reference.

Added benefit type code tables for Payment Adjustment (DN85) and Paid to Date (DN95) codes to be reported to the WCIS

Added industry code information and online reference.

Section P: Renamed Section O

Section Q: Renamed Section P

Version 2.1

Section A: Deleted sections referring to the variance period for data submission as the variance period has expired.

Section A: Eliminated manual data entry on the World Wide Web as a data transmission option.

Section A: Added File Transfer Protocol (FTP) as a data transmission option.

Section A: Clarified the implementation of EDI by adding an additional step. The Parallel Step now follows the Pilot Step creating a five step process.

Section B: Updated Trading Partner contact information.

Section C: Deleted references to the Release 2 format of EDI.

Section C: Eliminated manual data entry on the World Wide Web as a data transmission option.

Section D: Updated Labor Codes 138.6 and 138.7.

Section E: Updated WCIS regulations.

Section E: Replaced regulations pertaining to WCIS and First Reports of Injury with web-site addresses where regulations are posted.

Section E: Added Industry Code (DN25) to the list of required FROI data elements.

Section E: Removed Current Date Disability Began (DN144) from the list of required SROI data elements.

Section F: Deleted references to the Release 2 format of EDI.

Section F: Deleted reference to using the web site to submit claims data to the WCIS.

Section G: Added Parallel Phase to EDI transmission steps.

Section G: Updated Trading Partner contact information.

Section H: Deleted references to the Release 2 format of EDI.

Section J: Updated information on providers of EDI-related services.

Section K: Deleted references to the Release 2 format of EDI. Clarified language concerning criteria for submitting final (FN) and annual (AN) Subsequent Reports of Injury.

Section L: Deleted Release 2 data elements and references to the Release 2 format of EDI and deleted FROI UR data requirements.

Section L: Changed Social Security Number (DN42) from Conditional/Minor to Mandatory/Serious and added Industry Code (DN25) as a Conditional/Serious data element.

Section M: Deleted Release 2 data edits and references to the Release 2 format of EDI.

Section N: Deleted duplicate batch logic from the general rules for transaction processing and sequencing. Deleted Release 2 Maintenance Type Codes and references to the Release 2 format of EDI.

Section O: Updated Part of Body Codes for Subsequent Reports of Injury.
Section Q: Updated abbreviations and acronyms. Deleted references to the Release 2 format of EDI.

Appendix A: Deleted duplicate batch logic and references to the Release 2 format of EDI.

Version 2.0

Section B: Updated the contact information.

Section C: Language in sub-section 4 was updated to reflect the fact that Release 1 is the preferred file format even though WCIS still supports the Release 2 format.

Section C: Language in sub-section 7 was deleted on how to apply for a variance (delay) as the time deadline for requesting a variance has passed.

Section C: Modified title of current sub-section 7.

Section G: Updated contact information on where to get Trading Partner (TP) Profile forms and where to send the completed form.

Section G: Deleted the section that refers to a variance period as the variance period has expired.

Section G: Updated contact information on where the paper forms will be sent for parallel pilot phase.

Section G: Added two transmission mode options: Integrator and File Transfer Protocol (FTP).

Section G: Added a reference pointing to the February 15, 2002 version of the IAIABC Edit Matrix for information on error messages.

Section H: This section was modified to indicate that the mandatory switch to Release 2 has been postponed indefinitely.

Section H: Added information on the specific version of ANSI X12 that is compatible with WCIS.

Section I: Added detailed information on the FTP transmission mode option.

Section J: Corrected information on providers of EDI-related services.

Section K: Corrected the Trigger Event table to reflect a change in the revised WCIS system that Release 2 “AQ” MTC is not accepted. Alternatively, an “AU” MTC now needs to be sent.

Section L: Updated the Conditional Rules and Implementation Notes FROI: Release 1 and Release 2 data requirements Tables (See “Condition FROI” worksheet) to reflect that the Release 2 “AQ” MTC is not accepted in the revised WCIS system.

Section M: California-specific edits, noted in previous Implementation Guides as “planned edits”, are adopted.

Section N: Updated to indicate that First Reports and Subsequent reports cannot be sent together in a single batch for Release 2 files.

Section N: Updated to reflect the various differences between the revised WCIS system and the old system. This information was included in ENEWS #36 and #37. It is also detailed in Section R. Please note:

- For new claims submitted to the revised WCIS system, TPs will receive a new JCN that will be 22 digits. Existing claims will continue to keep the original 12 digit JCN. Duplicate batches will not be processed. A duplicate batch has the same Sender ID (DN98), Date Transmission Sent date (DN100), and Time Transmission Sent time (DN101) as an earlier batch received and processed by WCIS.

- The MTC date must be less than or equal to the current date.
- Rules that apply to Release 2 “AQ” transactions have been removed.
- Only one “IP” transaction for the same claim will be allowed.
- Medical-only claims with no indemnity payments may be closed with an “AN” MTC (must include a Claim Status = “closed”. “FN” MTC not required to close this type of claim.
- ANSI X12 “ANs” must include the proper ANSI “frequency code”.
- Transaction-level MTC rule for “FS” MTC: Must contain benefit record with Payment/Adjustment Code=240 or 524.
- Secondary Match for FROIs, other than “AU” transactions, also applies to SROIs.
- Compensatory Death MTC automatically closes all Indemnity Benefits (BENs). MTCs that open these closed BENs will be rejected.

Section O: Updates to various code tables.

Section P: Removed the IAIABC EDI implementation Guide Order form as a free downloadable version is posted on the IAIABC web site.

Section P: Removed explanation of differences between Release 1 and Release 2 data formats.

Section Q: Deleted the description of full variance as the variance period has expired.

Appendix A: New section added to detail differences that TPs need to note between the former and revised WCIS systems and past issues that may need clarification.

Version 1.2

Section A: Updated information on paper reporting requirements to the Division of Labor Statistics and Research (DLSR) during production phase.

Section B: Added description of WCIS e-News that is the WCIS e-mail newsletter.

Section C: Added information on obtaining from the IAIABC a license to use the EDI transaction standards for transmitting data to a state.

Section E: Added copy of letter from Department of Industrial Relations (DIR) stating that fulfilling the requirements of the WCIS regulations regarding transmission of First Reports satisfies the obligation to send paper Employer's Reports (Form 5020) to DLSR. Added DLSR regulations pertinent to the filing of first reports.

Section F: E-mail address of State updated in Section D of Trading Partner Profile Form.

Section G: Information on paper reporting requirements to DLSR during production phase updated. Submission requirement of paper Doctor's First Report (Form 5021) to WCIS during piloting phase changed to optional. Added that ANSI Trading Partners receive 997 Functional Acknowledgment in addition to 824 Detailed Acknowledgment. References to Section I – Transmission Modes added for e-mail and web site Trading Partners. Statements that web site users be able to receive e-mail acknowledgments removed. Piloting procedures clarified.

Section H: Modified to indicate that the ANSI X12 file format for First and Subsequent Reports of Injury Release 2 will be accepted as soon as an implementation guide has been approved by *either* ANSI or IAIABC. Updated WCIS schedule of Supported Transactions.

Section I: Clarified the fact that the Division of Workers' Compensation (DWC) will not pay VAN charges for either incoming or outgoing EDI transmissions. Added specific steps on how to send data as an e-mail attachment or through DWC's website.

Section J: Added new EDI service providers to listing.

Section K: Added Release 1 Subsequent Report table.

Section L: Added Release 1 Subsequent Report table of required data elements and updated data requirements.

Section M: Planned edit on Claim Administrator Claim Number (DN15) removed.

Section N: Deleted reference to CO being preceded by an error message. Also deleted paragraph stating that claims administrators can only update First Report Data elements. Added Benefit Processing Rules and clarified sequencing rules for First and Subsequent Reports. Fixed matching rules table to indicate that Jurisdiction Claim Number must currently be provided on MTC=01, 02, CO, and all subsequent reports. Clarified description of when secondary match data are used.

Section O: Added footnote to table of Employee Mailing Country Codes. Added code 99 – whole body – to Part of Body code list.

Section P: Added information on obtaining from the IAIABC a license to use the EDI transaction standards for transmitting data to a state.

Section Q: Added section on EDI Terminology.

Version 1.1

Sections A and C: Includes minor updates to reflect final regulations.

Section E: Contains updated WCIS regulations, as approved by the California Office of Administrative Law on October 6, 1999.

Section F: Includes a new subsection on who needs to complete the Trading Partner Profile form.

Section G: Introductory paragraph added. Updated to reflect current regulations.

Section J: Includes updated list of EDI service providers.

Section K: Specifies which Maintenance Type Codes are not accepted by WCIS.

Section L: Minor updates to data element requirements and conditional statements.

Section N: Updated “Matching Rules and Processes” table, and revised explanation in “Changed or Corrected Data”.

Section O: Removed code lists for Application Acknowledgment Code, Denial Reason Code, and Employment Status Code.

Version 1.02

Reporting deadlines have been revised throughout to match new timeline in proposed regulations dated June 22, 1999.

Section G: Test, pilot, production process has been revised to provide simpler and more efficient movement through early phases of testing.

Section H: WCIS support for Release 2 file formats has been changed, reflecting recent IAIABC approval of an ANSI X12 format for First and Subsequent Reports of Injury, Release 2.

Version 1.01

Includes revised regulations, removing from the current rulemaking the requirements to submit Medical Bill/Payment Reports.

References to medical reporting requirements are eliminated from throughout the current implementation materials.

Version 1.00

The version previous to 1.00 was not numbered, but was released in February, 1999. Version 1.00 includes substantial modifications throughout. The most significant of these are:

WCIS support for all Maintenance Type Codes has been added.

A schedule has been added indicating what file formats (Release 1, Release 2, flat-file, ANSI X12) will be supported and when.

Test, pilot, and production process has been specified.

California-specific data edits have been specified.

Matching rules and processes have been specified.

Transaction sequencing requirements have been specified.

Processing of acquired claims transactions has been specified.

Lists of valid codes have been added.